

SA100 USER MANUAL



Content

Section 1 Before Start	1
1.1 General Introductions	1
1.2 Battery	2
1.3 This Product and AC Adapter	3
1.4 Regulatory Information	5
1.4.1 For EU	6
1.4.2 For USA	7
Section 2 Getting Started	9
2.1 Introduction	9
2.2 Unpacking	10
2.3 Description of Components	11
2.4 First-Time Operation	15
2.4.1 Installing SIM Card/Micro SD Card	15
2.4.2 Connecting to AC Adapter	15
2.4.3 Start the tablet	16
2.5 Resetting to Factory Defaults	17
Section 3 Basic Operations	20
3.1 Using the Touchscreen	20
3.1.1 Controlling the Touchscreen	20
3.1.2 the Introduction of Home screen	21
3.1.3 Personalizing Home Screen	22
3.2 Changing Touchscreen Modes	25
3.3 Using the On-Screen Keyboard	26
3.4 Display Settings	29
3.5 Sound Settings	30
3.5.1 Sound Setting	30
3.5.2 Adjusting Volume	31
3.6 Language and Keyboard Setting	32
3.7 Managing the Power	35
3.8 About Tablet	36
Section 4 Connecting Networks and Wireless Devices	37
4.1 Mobile Networks Connection	37
4.1.1 Checking Mobile Network (4G/LTE) Connection	37



4.1.2 Managing Data Service	37
4.2 WLAN Networks Connection	40
4.3 BT Devices Connection	43
4.3.1 Turn on BT Connection	43
4.3.2 Connecting/Disconnect the BT Device	44
4.4 Using Barcode Reader (Optional)	47
4.5 Using NFC Tags	48
Section 5 Troubleshoot	49



Section 1 Before Start

1.1 General Introductions

To avoid or reduce the risk of electric shock, fire, fault, physical injury, loss of life, and damage to device or property, always observe the following cautions.



DANGER

Indicates an imminently hazardous situation that, if not avoided, will result in death or serious injury.



WARNING

Indicates a potentially hazardous situation or an accidental use that, if not avoided, could result in death or serious injury.

CAUTION

Caution alert indicates potential damage to hardware and explains how to avoid the potential problem.

NOTE

Indicates an important note that is essential to you .



1.2 Battery



DANGER

- If the battery deteriorates, replace it with a new one.
- Do not expose the battery to fire, excessive heat or direct sunlight.
- Do not expose the battery to water or other liquids.
- Do not disassemble, modify, insert foreign objects into the battery or subject it to impact.
- Do not throw the battery or subject it to strong impact such as dropping or applying high voltage.
- Do not short the positive(+) and negative(-) contacts.
- Do not carry the battery around or store it with necklaces, hair clips, etc.
- The battery is for use with this product only. Do not use it together with any other products.



WARNING

- Do not touch leaked electrolyte from the battery.
- Electrolyte may enter the eyes and cause blindness, or may contact skin and cause rashes. Rinse with clean water, do not rub, and seek medical advice.
- Do not place the battery in a microwave oven or pressurized container. Sudden heating or pressurization may damage the battery and cause electrolyte leakage, excessive heating, smoke, burst, or fire.
- If the battery leaks electrolyte or smells, keep the battery away from fire.



1.3 This Product and AC Adapter

WARNING

- Do not expose the AC adapter or cable to water or other liquids, as this may cause a short circuit or overheating, which may result in electric shock or fire. If the product gets wet, unplug the AC plug of the AC adapter immediately.
- Do not touch the product, AC adapter or cable during a lightning storm when the product is connected to an AC adapter, as this may result in electric shock.
- Do not insert a metal object into the plug of the AC adapter or cable, as this may result in fire, burns or electric shock.
- Do not insert foreign objects into the product, otherwise it may lead to short circuit or overheating, which in turn may cause electric shock or fire.
- When in prolonged use, do not expose your skin to the product for a long time to avoid possible low temperature burns.
- Do not allow conductive materials to come into contact with the expansion bus connector, as this may cause a short circuit and overheating, which in turn may lead to battery electrolyte leakage, overheating, smoke, burst or fire.
- Do not disassemble the product without authorization, as this may cause a short circuit or overheating, which in turn may cause electric shock or fire.
- Do not place the product in a microwave oven or an electromagnetic cooker as this may cause a short circuit or overheating, which may result in electric shock or fire.
- Keep small parts such as SD card out of the reach of infants and children.
- Please avoid listening at high volume for long time as this may result in damage or loss of hearing. High volume may also make it difficult to hear the surrounding sounds, which may lead to accidents. Use only the specified battery, otherwise it may cause electrolyte leakage, overheating, smoke, burst or fire.
- Do not operate the product while walking, riding a bicycle or driving, etc., as this may result in an accident or a fall.
- When using the product in areas with high concentrations of moisture, steam, dust, oily vapors, etc., make sure to close the port cover to avoid the entry of foreign objects, which may in turn lead to possible electric shock or fire.
- When the product is damaged, water or foreign objects enter the product, the product smokes, the product emits abnormal odor or sound, or the product overheats, stop using the product immediately, unplug the AC plug of the AC adapter, remove the battery and contact technical service.



- When exposed to certain light patterns or flashing lights for long time, very few people may experience seizures or blackouts. If you experience any discomfort while staring at the flashing lights on the screen, stop using the product immediately and consult your doctor.
- Clean the AC plug of the AC adapter regularly. If dust or other debris stores up on the plug, moisture, etc. may cause insulation defects, which in turn may lead to fire.
- Do not damage or modify the cable. Do not place it near hot tools, twist, pull hard, or deform the cable. Continued use of a damaged AC adaptor or cable may result in fire or electric shock.
- Plug the AC plug of the AC adapter completely in, otherwise a fire may result from overheating or electric shock.
- Do not pull out or insert the AC plug of the AC adapter if your hands are wet. It may result in electric shock. Do not use a damaged AC plug or loose AC outlet.
- Do not use this product near electronic equipment used for high-precision control or weak signals, such as: hearing aids, implantable pacemakers and implantable cardioverter-defibrillators, other medical devices, fire alarms, automatic doors, and other automatic control devices. RF signals generated by this product may interfere with such electronic equipment and cause accidents due to malfunction.
- In aircraft, connect the AC adapter/charger only to an AC outlet specifically approved for such use.
- Do not connect the AC adapter to a power source other than a standard household AC outlet, as this may cause a fire due to overheating. Connecting to a DC/AC converter(inverter) may damage the AC adapter.



1.4 Regulatory Information

This Product and Your Health

The radio frequency electromagnetic energy of this product functions within radio frequency safety standards. We believe this product is safe for use. In certain situations or environments, the use of this product may be restricted by the responsible representatives of the building or organization. These situations may include, for example, the use of this product in aircraft, or in medical facilities where equipment in using is sensitive to external RF energy, or in any other environment where the risk of interference with other equipment or services is considered or determined to be harmful. If you are unsure of the policies that apply to the use of wireless devices in a particular organization or environment, we encourage you to request authorization to use the product before turning on the device.

Information to the User

We are not responsible for any radio or television interference caused by unauthorized changing to this product, and for correcting interference caused by such unauthorized changing. We and our authorized distribution partners or resellers are not responsible for damages or violations of government regulations that may result from failure to comply with these standards.

Potentially Explosive Atmosphere

Sparks in areas with potentially explosive atmospheres may cause an explosion or fire, to avoid personal injury or even death, in chemical plants, fuel or chemical transfer or storage facilities, below decks on ships, vehicles using oil or natural gas, refueling areas, or the atmosphere areas containing particles such as grain, dust, or metal powder, and any other area where it is generally recommended that you turn off the engine of your vehicle, turn off the product, and obey all signs and instructions.

Driving

Do not operate the product while driving, safe driving is your primary responsibility. Get off the road and pull over before making or answering a phone call. Do not place or install the product in the area above the air bag or in the deployment area. If the air bag inflates, serious personal injury and/or damage could result. Check the laws and regulations in the area where you drive, and always obey them. Regularly check that the product is securely mounted and functioning properly in your vehicle. Radio frequency signals may affect improperly installed or inadequately shielded electronic systems in motor vehicles.

Emergency Communications

Network connections can be disrupted by a variety of factors, such as low battery levels, weak radio signals, and problems with service networks. Do not rely solely on the product for essential



or emergency communications.

Antenna

Do not replace the antenna without authorization. Unauthorized antennas, modifications, or attachments may cause damage to the product and may even violate regulations that are designed to protect consumers and ensure safety. The product performance may be affected when the device is turned on, if the antenna area is touched or covered.

1.4.1 For EU

After the laboratory measurements the Max. SAR values for this device is: Body: 0.466 W/kg.

- The device complies with RF specifications when the device used at 0cm from your body.
- The product shall only be connected to a USB interface of version USB3.1.



- Use carefully with the earphone maybe possible excessive sound pressure from earphones and headphones can cause hearing loss.
- **CAUTION: RISK OF EXPLOSION IF BATTERY IS REPLACED BY AN INCORRECT TYPE. DISPOSE OF USED BATTERIES ACCORDING TO THE INSTRUCTIONS.**
- Adapter shall be installed near the equipment and shall be easily accessible.
- The plug considered as disconnect device of adapter.
- EUT Operating temperature range: -10-55°C.
- This product can be used across EU member states.
- Declaration of Conformity

Hereby, Shanghai UniOne Science & Technology Co., Ltd. declares that the radio equipment type GTW6101 is in compliance with Directive 2014/53/EU. The full text of the EU declaration of conformity is available at the following internet address: www.rugstorm.com/download.



- Operations in the 5.15-5.25 GHz band are restricted to indoor usage only.
- This Frequency the following Member States or the geographical area within a Member State where restrictions on putting into service or requirements for authorization of use exist.



				
BE	BG	CZ	DK	DE
EE	IE	EL	ES	FR
HR	IT	CY	LV	LT
LU	HU	MT	NL	AT
PL	PT	RO	SI	SK
FI	SE	UK(NI)		

Frequency Range And Maximum Power :

Frequency	Power	Frequency	Power
LTE Band 1	22.56 dBm	Wi-Fi 2412-2472 MHz	16.24 dBm
LTE Band 3	23.62 dBm	Wi-Fi 5150-5250 MHz	14.57 dBm
LTE Band 7	22.92 dBm	Wi-Fi 5250-5350 MHz	14.57 dBm
LTE Band 8	23.5 dBm	Wi-Fi 5470-5725 MHz	14.57 dBm
LTE Band 20	23.31 dBm	Wi-Fi 5745-5825 MHz	12.92 dBm
LTE Band 28	23.22 dBm	Bluetooth: 2402-2480 MHz	13.27 dBm
LTE Band 38	22.72 dBm	GSM 900	34.8 dBm
LTE CA Band 38	22.46 dBm	GSM 1800	30.6 dBm
LTE Band 40	24.18 dBm	WCDMA 2100	24.00 dBm
LTE CA Band 40	24.58 dBm	WCDMA 2100	24.79 dBm
5G N1	24.71 dBm	5G N41	26.47 dBm
5G N3	23.17 dBm	5G N77	27.96 dBm
5G N20	22.79 dBm	5G N78	27.81 dBm
5G N28	20.88 dBm		

1.4.2 For USA

This equipment has been tested and found to comply with the limits for a Class B digital device, pursuant to part 15 of the FCC Rules. These limits are designed to provide reasonable protection against harmful interference in a residential installation. This equipment generates uses and can radiate radio frequency energy and, if not installed and used in accordance with the instructions, may cause harmful interference to radio communications. However, there is no guarantee that interference will not occur in a particular installation. If this equipment does cause harmful interference to radio or television reception, which can be determined by turning the equipment off and on, the user is encouraged to try to correct the interference by one or more of the following measures:

- Reorient or relocate the receiving antenna.



- Increase the separation between the equipment and receiver.
- Connect the equipment into an outlet on a circuit different from that to which the receiver is connected.
- Consult the dealer or an experienced radio/TV technician for help.

CAUTION: ANY CHANGES OR MODIFICATIONS TO THIS DEVICE NOT EXPLICITLY APPROVED BY MANUFACTURE COULD VOID YOUR AUTHORITY TO OPERATE THIS EQUIPMENT.



- This device complies with part 15 of the FCC Rules. Operation is subject to the following two conditions:
 - (1) This device may not cause harmful interference, and
 - (2) This device must accept any interference received, including interference that may cause undesired operation.
- RF Exposure Information and Statement:

The SAR limit of USA (FCC) is 1.6 W/kg averaged over one gram of tissue.

Device types: GTW6101 (FCC ID: 2A96I-GTW6101) has also been tested against this SAR limit. The highest SAR value reported under this standard during product certification for use on the body is 1.574 W/kg. This device was tested for typical body-worn operations with the back of the handset kept 0mm from the body. To maintain compliance with FCC RF exposure requirements, use accessories that maintain a 0mm separation distance between the user's body and the back of the handset. The use of belt clips, holsters and similar accessories should not contain metallic components in its assembly. The use of accessories that do not satisfy these requirements may not comply with FCC RF exposure requirements, and should be avoided.

This device was tested for typical body-worn operations. To comply with RF exposure requirements, a minimum separation distance of 10mm must be maintained between the user's body and the handset, including the antenna. Third-party belt-clips, holsters, and similar accessories used by this device should not contain any metallic components. Body-worn accessories that do not meet these requirements may not comply with RF exposure requirements and should be avoided. Use only the supplied or an approved antenna.

Operations in the 5.15-5.25 GHz band are restricted to indoor usage only.



Section 2 Getting Started

2.1 Introduction





Exemplifying the pinnacle of thin and light design, with thinnest 11.8mm and 635g weight, SA100 offers users a comfortable handheld working experience. Meanwhile, as a member of the S series, SA100 provides IP65 water and dust protection, along with 1.2m drop resistance. Powered by cutting-edge 5G communication technology, SA100 exceeds the requirements for data transmission volume and speed in industrial applications. It delivers stable wireless communication performance across diverse work scenarios. To facilitate field data acquisition, SA100 offers an optional built-in 1D/2D barcode scanner featuring Honeywell N6703 scan engine.

Key Features

- Android™ 12, Qualcomm® SM4350-AC
- 10.1" 1920 × 1200 resolution
- Support wet & glove-friendly touch
- 6GB LPDDR4X, 128GB UFS
- IP65 protection, 1.2m drop, MIL-STD-810H
- Wi-Fi, BT v5.1, NFC, 4G LTE/5G
- 32MP rear camera AF/LED flash, 8MP front camera
- Built-in GPS
- Optional barcode scanner (Honeywell N6703)
- Complete Accessory Package to facilitate your work

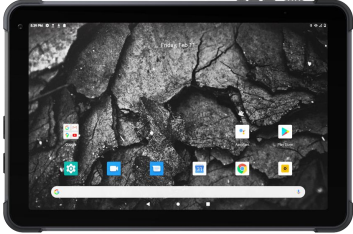

2.2 Unpacking

Tablet	Power Adapter
	
Quick Start Guide	Power Cord
	

NOTE:

- The image is for reference only, and the actual product may have slight variations.
- The adapter accompanying the device may vary depending on the country of export.



2.3 Description of Components

Front Components

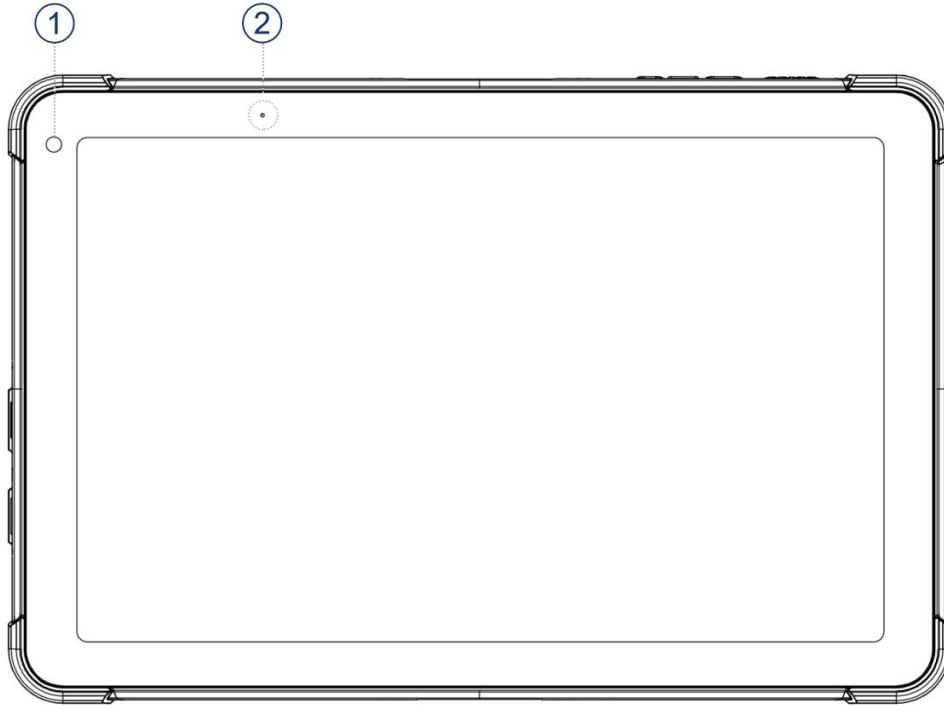

NO	Item	Description
①	Front Camera	Allows you to use the camera function. The front camera supports 8MP.
②	Light Sensor	Senses the ambient light for automatic adjustments of the display backlight.



Rear Components

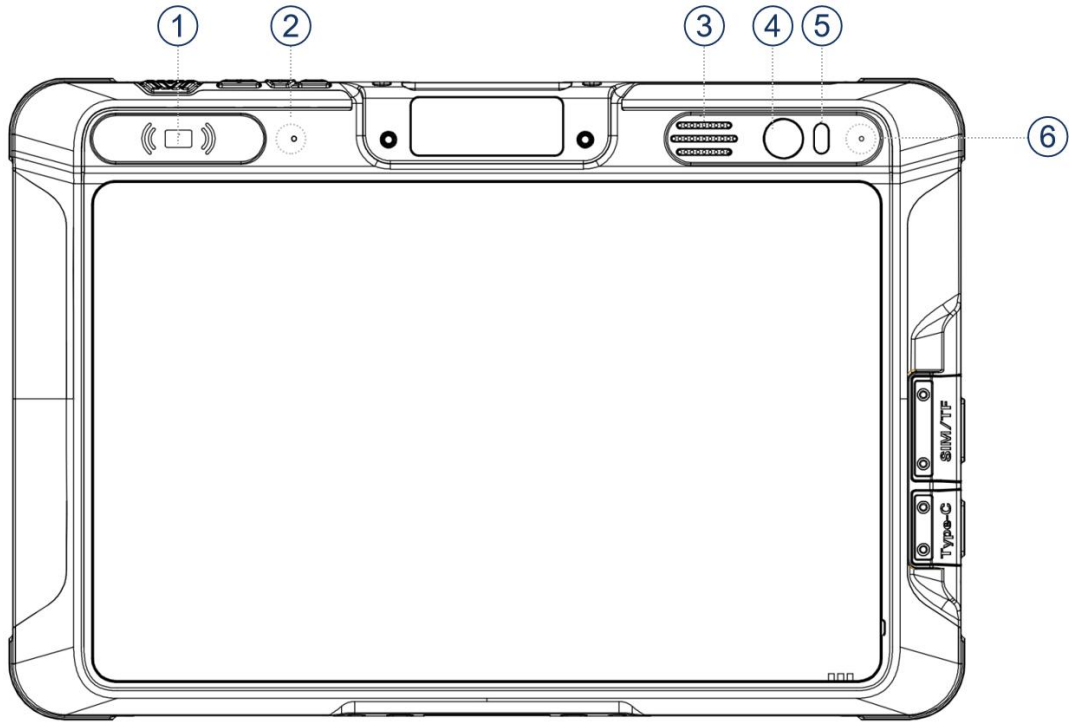

NO	Item	Description
①	NFC Reader	Reading NFC tags.
②	Waterproof Breathable Vent	Balance the internal and external air pressure and prevent water and dust from entering the tablet.
③	Speaker	Emit the sound.
④	Camera	Allows you to use the camera function. The rear camera supports 32MP with autofocus.
⑤	Flashlight	Provides extra light while taking pictures.
⑥	Microphone	Enable audio recording for communication, vocal performance in music, speech, and general sound recording.



Left-Side Components

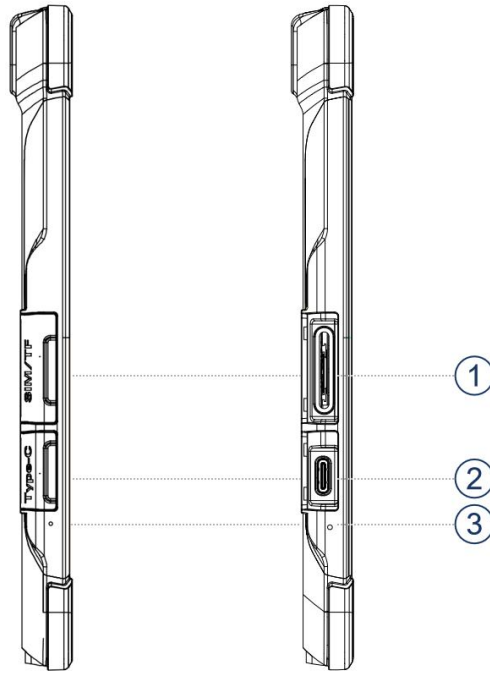

NO	Item	Description
①	Micro SD/SIM Card Slot	Service window with 2 in 1 card tray to insert SD Card and SIM card.
②	USB3.1 Type-C	USB 3.1 port connects to USB devices.
③	Microphone	Enable audio recording for communication, vocal performance in music, speech, and general sound recording.



Top Components

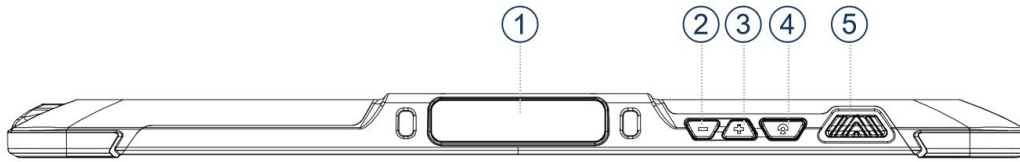

NO	Item	Description
①	Optional Barcode Scanner	Scan and read 1D/2D barcode.
②	Volume -	Decrease the volume.
③	Volume +	Increase the volume.
④	Power Button	Short Press: Goes into or wakes up from sleep mode.
		Long Press: ① Powers on the device from the off state. ② Opens a menu displaying the power off option when the device is powered on. ③ The device will restart when a press longer than 8 seconds.
⑤	Function Button	Without Barcode: return to the desktop.
		With Barcode: launch the barcode scanner if your model has the option.

Bottom Components

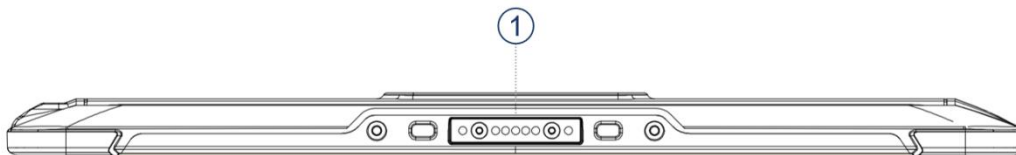

NO	Item	Description
①	Charging Connector	Port to docking solutions such as office dock, vehicle dock to provide power.



2.4 First-Time Operation

To start to operate the tablet, you can follow below steps:

1. Read Quick Start Guide firstly.
2. Install SD card or SIM card if necessary.
3. Charge the tablet.
4. Start the tablet.

2.4.1 Installing SIM Card/Micro SD Card

1. Unplug SIM/SD slot protective cover.
2. Hold the edge of the SIM/SD card holder to pull out the card holder.
3. Put the SIM card or SD card on the right position of the card holder.
4. Insert card holder all the way in.
5. Plug the SIM/SD slot protective cover.

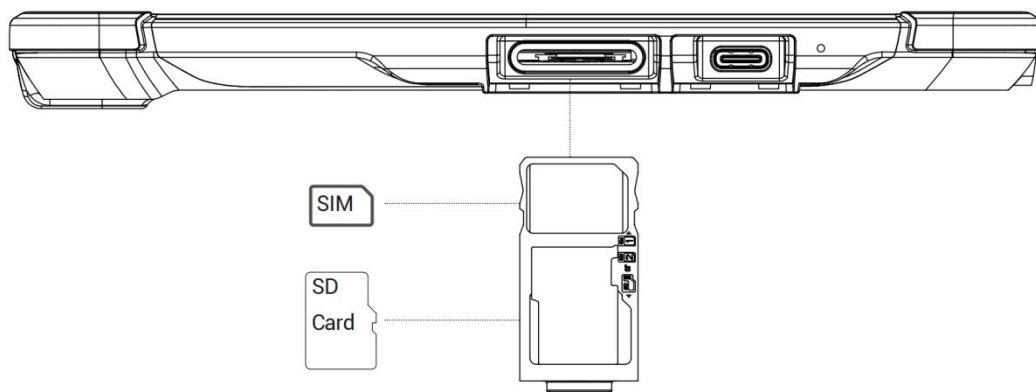

2.4.2 Connecting to AC Adapter

CAUTION: Please only use the AC adapter that comes with your Tablet Computer. Using any other AC adapters may result in damage to both the Tablet Computer and the Battery.

NOTE:

The device is powered by both external AC adapter and internal battery. It is advised to use AC power when you power on the Tablet Computer for the first time.

1. Open the I/O protect cover on the left by pulling out the latch.
2. Plug the USB cable into the USB type-C connector of the tablet.
3. Plug the USB cable to the AC adapter.
4. Plug the adapter to the electrical outlet.

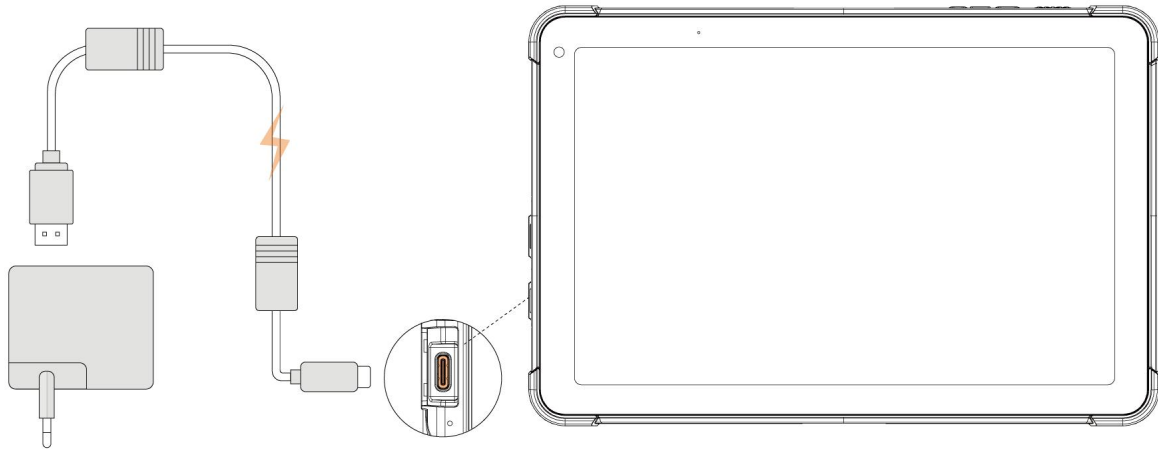

The electrical outlet is supplying power to the AC adapter, which in turn powers your Tablet PC. Now, you are ready to turn on the Tablet PC.

2.4.3 Start the tablet

Turn on

Press the power button  for 1 second until the logo is displayed.

Turn off

Press and hold the power button  until a menu pops up, tap **Power off**.

Wake up the tablet

If the tablet remains inactivity for a period, the screen will dim and eventually darken to conserve battery power.

To wake up the tablet:

1. Press the Power button located on the top side of the tablet.
2. Swipe up the screen to unlock.



2.5 Resetting to Factory Defaults

To reset the device to factory defaults:

1. Swipe upward to unlock, and then open **Settings** app.
2. Tap **System**, user can select to back up application data, WLAN passwords and other settings to Google servers by tapping **Backup**.

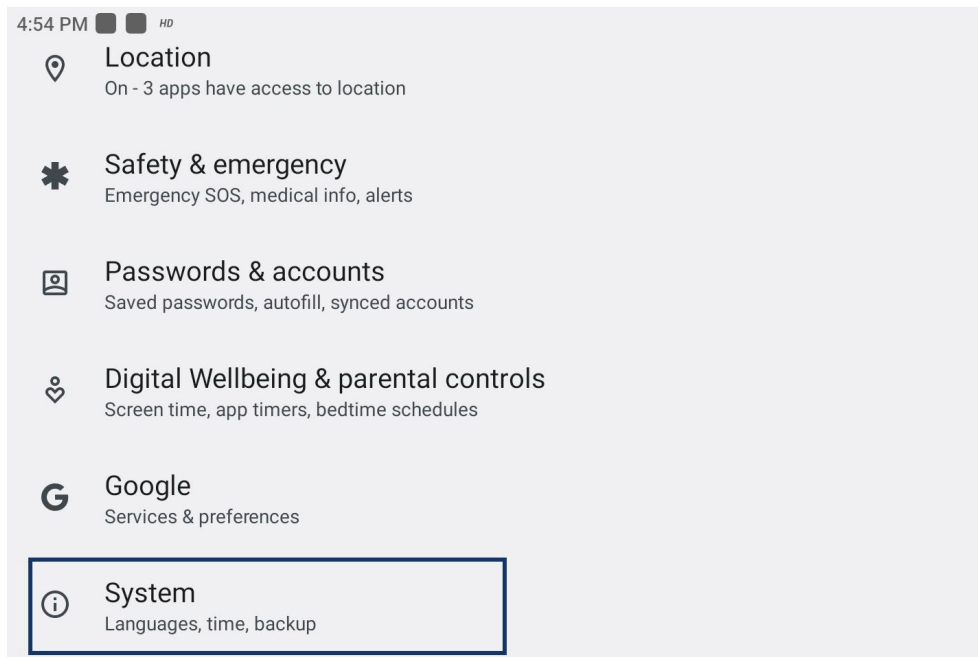

3. Tap **Reset options**.

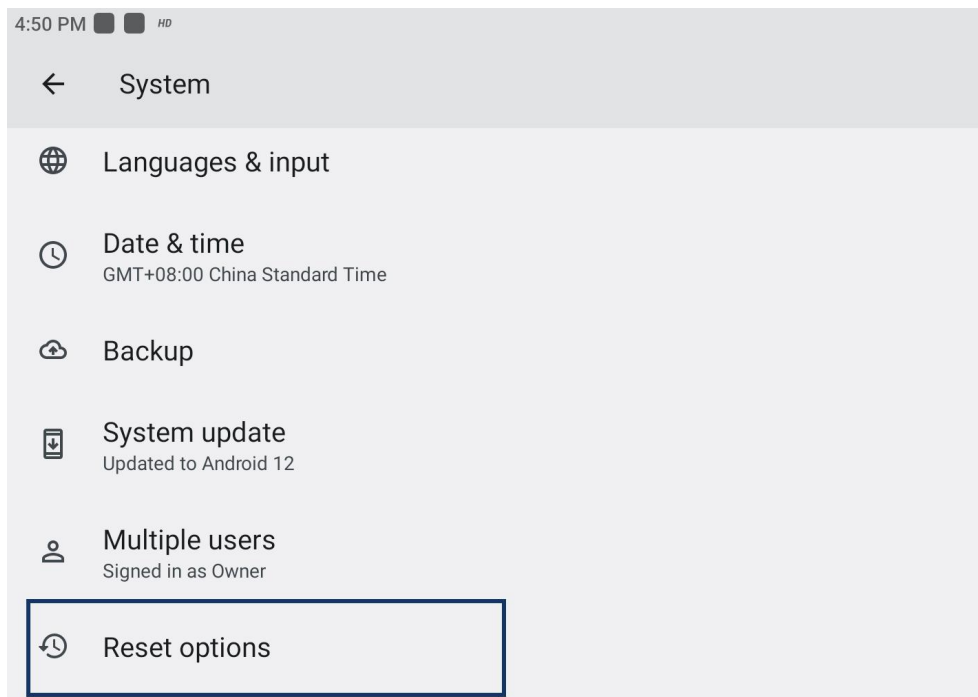

4. Tap **Erase all data (factory reset)** to reset the tablet.

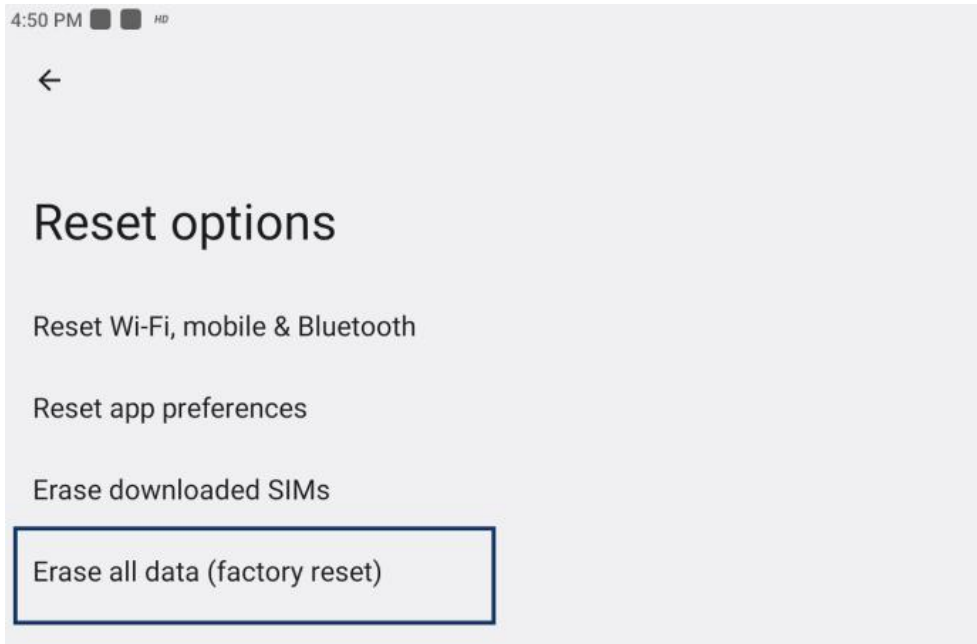

5. Read all the available information and then press Erase all data to delete all the data in storage such as music or photo.

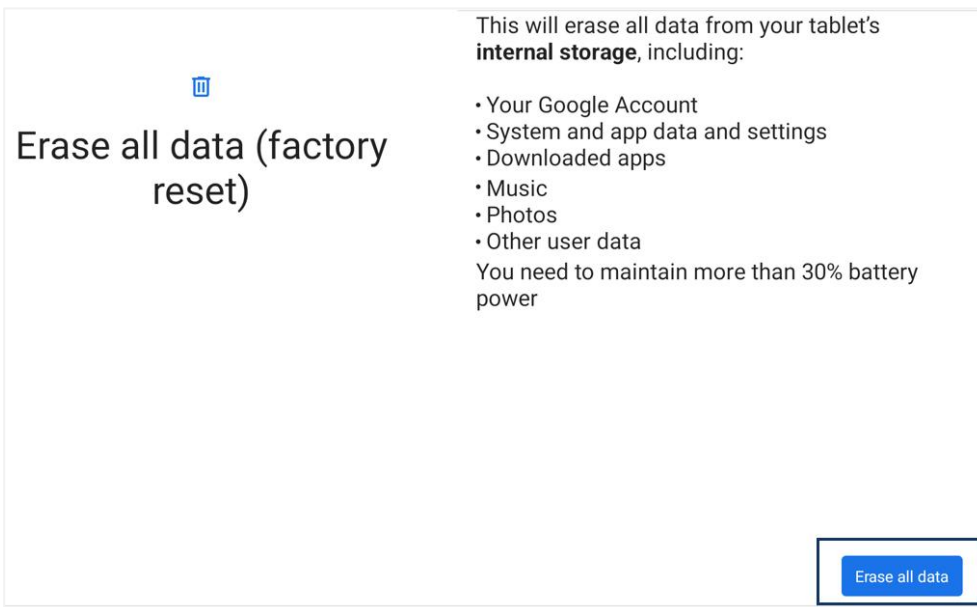

6. Press Erase all data to remove all your personal information and downloaded apps.





Erase all data?

All of your personal information and downloaded apps will be deleted. You can't undo this action.

Erase all data









Section 3 Basic Operations

This section is a common manual about the setting of the SA100 tablet, including the screen, status icons and audio and the power management, which provide instructions to operate the feature of the tablet.

3.1 Using the Touchscreen

3.1.1 Controlling the Touchscreen

The touchscreen is compatible with the primary gesture for Android.

Gesture	Action	Description
Tap		To activate or enable something.
Tap & Hold		To touch something on the screen and keep the gesture until it responds.
Touch, Hold and Drag		To touch and hold something on the screen, then move it to the target position.
Swipe		To swiftly move the finger across the screen.
Double Tap		Double-tap rapidly on a webpage, screen, or app to zoom in.
Scale		Spread two fingers apart or pinch on the screen.

Note:

- Ensure that the touchscreen does not come in contact with other electrical devices, as electrostatic discharges may lead to touchscreen malfunctions.



- Avoid tapping the touchscreen with sharp objects or applying excessive pressure with your fingertips to prevent damage.
- It is advisable to refrain from using static graphics on the touchscreen for prolonged periods, as this may cause afterimages (screen burn-in) or ghosting.

3.1.2 the Introduction of Home screen

Home screen and App screen

The Home screen serves as the initial access point for all device functions. It displays widgets, app shortcuts, and additional features.

The Apps screen exhibits icons for all apps, including recently installed ones.

On the Home screen, swipe upwards to open the Apps screen.

To return to the Home screen, swipe upwards or downwards on the Apps screen. Alternatively, press the Home key, the back key or return button.

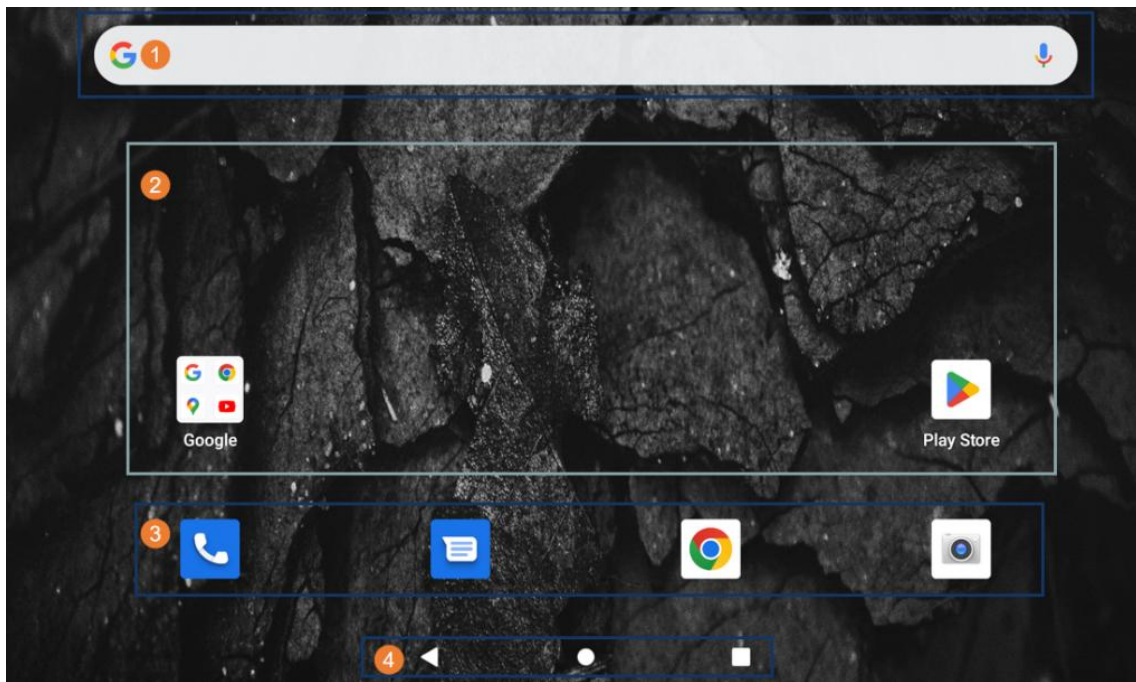

No.	Item	Description
①	Finder	To provide quick access to search specific content.
②	Main Panel	To displays widgets, shortcuts to apps, and more.
③	Hot seat	To place user's favorite app.
④	System Navigation	To enable users to move between different screens, switch between apps, and access the device's settings with controlling 3-buttons or gesture.



3.1.3 Personalizing Home Screen

Users have the ability to place application icons, shortcuts, widgets, and other elements on any free space of any Home screen. Additionally, users can modify the wallpaper as desired.

To change wallpaper on the HOME SCREEN:

1. Swipe up from the bottom of the home screen, tap **Settings** , and then tap **Wallpaper**.

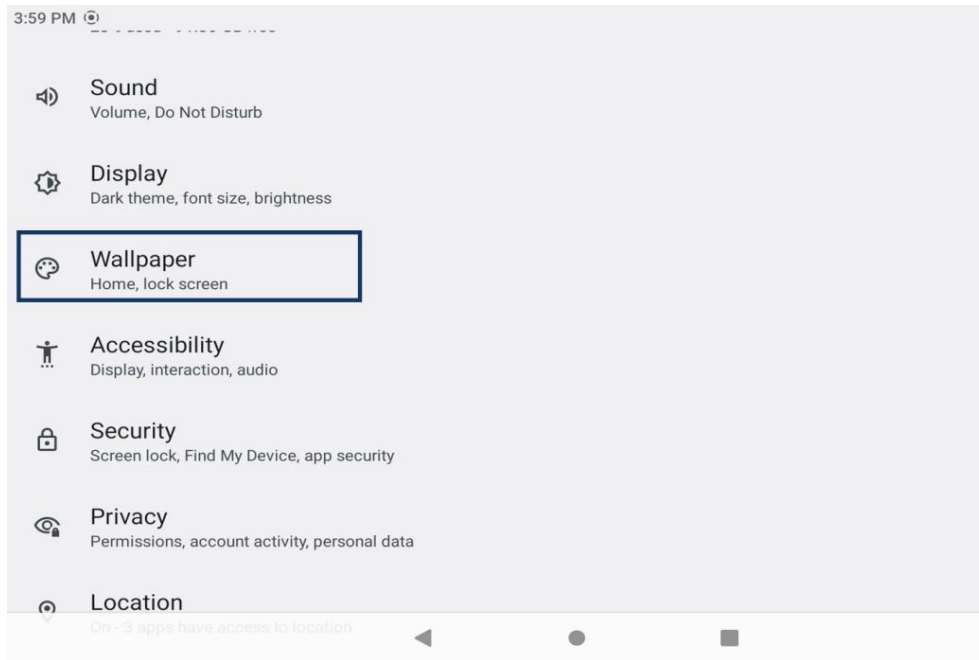

2. In the Wallpaper menu select the location of wallpaper, and then tap the type of item you want to add.

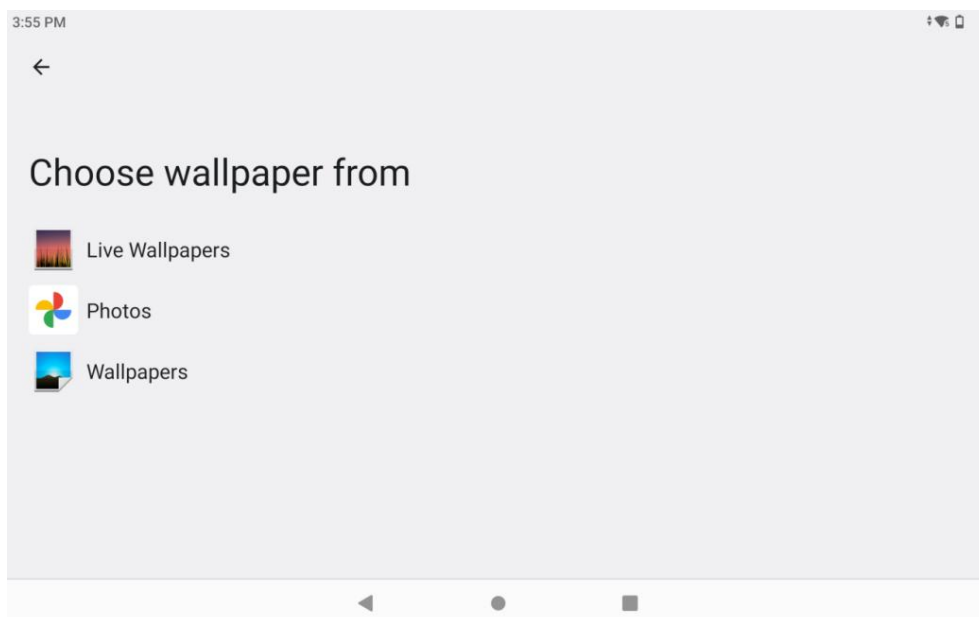



To move an item on the Home Screen:

1. Tap and hold the item you want to move, until it can be moved. Drag it to a new location on the screen.

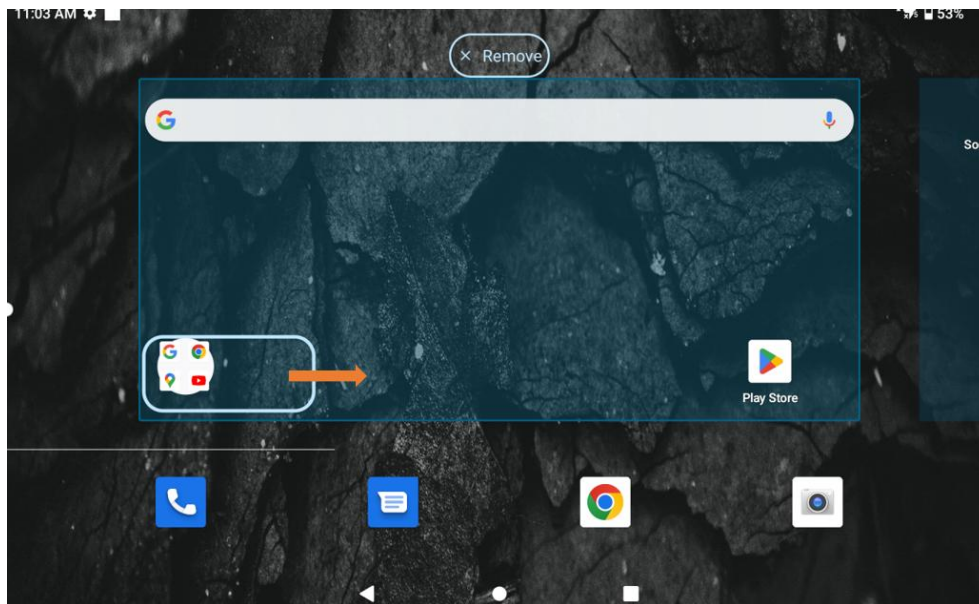

2. Place the item to the target position and release your finger.

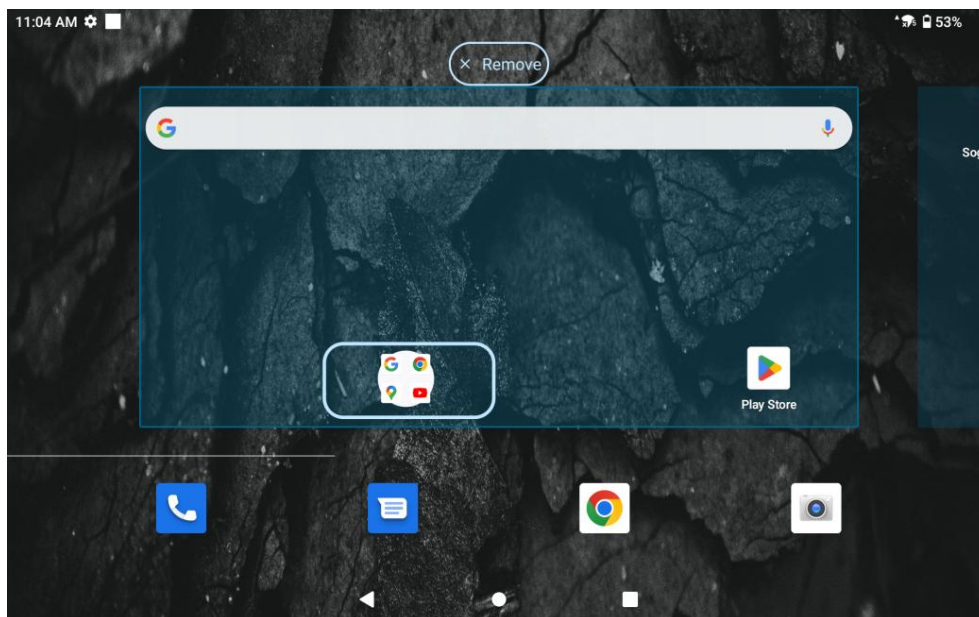

To remove items from the Home Screen:

1. Tap and hold the item you want to remove. The launcher icon will show Remove on the top of the screen.
2. Drag the item you want to remove to the Remove icon.

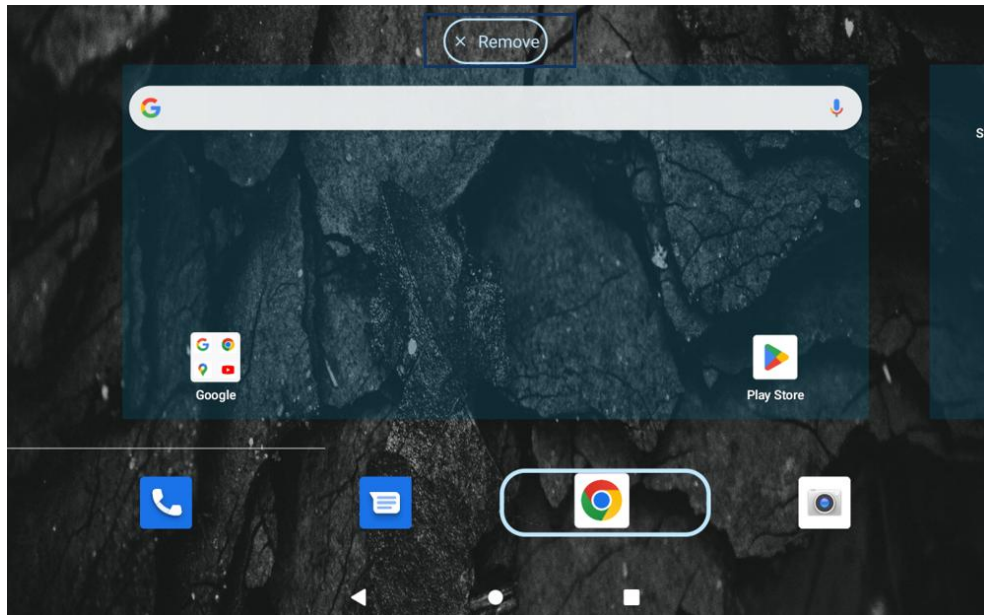

3. When the icon turns colored, release your finger.



3.2 Changing Touchscreen Modes

The tablet touchscreen supports normal and glove mode. The access to change the touchscreen mode is in Accessibility settings.

Mode	Description
Hand/ Water Resistant Mode (Default)	In the Hand/Water Resistant mode, the touchscreen is designed to ignore inaccurate inputs caused by liquid droplets. Once the liquid is cleared, the touchscreen will resume accepting touch inputs from bare fingertips. This mode setting is enabled by default. Supports input by: <ul style="list-style-type: none"> • Rubber tip passive stylus • Bare fingertips
Glove Mode	In Glove mode, the touchscreen is capable of recognizing inputs even when the user is wearing gloves while operating it. Supports input by: <ul style="list-style-type: none"> • Glove • Rubber tip passive stylus • Bare fingertips

To change touch mode:

1. Launch **Setting** → **Accessibility** → **Glove mode**.
2. Tap the switch to enable Glove mode.





3.3 Using the On-Screen Keyboard

Users have the capability to input text through the On-Screen Keyboard. Certain applications will automatically activate the keyboard, while in others, users must tap on a designated text field to prompt its appearance. This allows users to conveniently enter text using the On-Screen Keyboard.

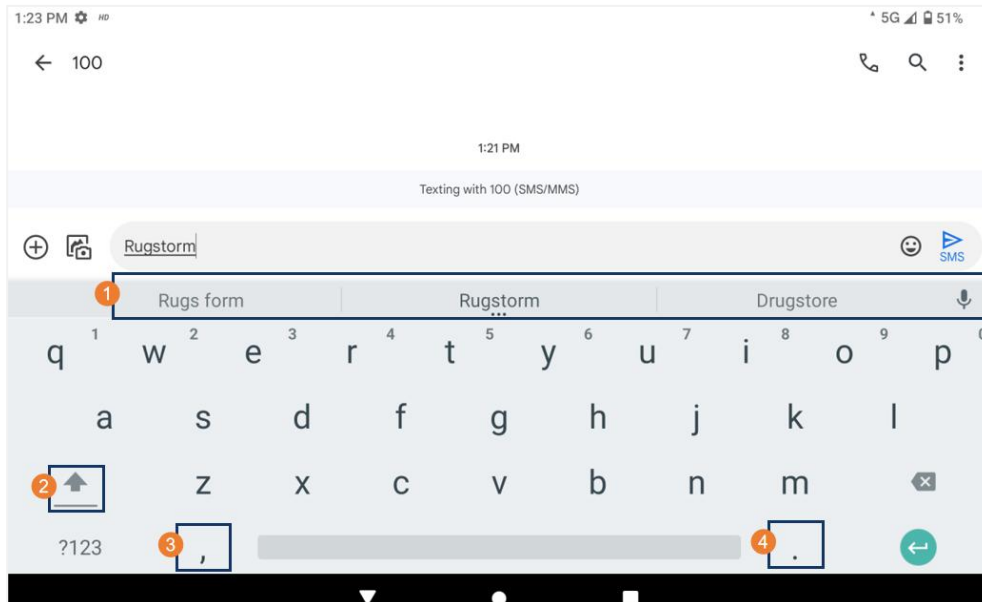

No.	Item	Description
①	Suggestions	Tap a suggestion to enter it in the place of the underlined.
②	Capitalize	Tap once to capitalize the alphabet.
③	,	Short press to to enter a comma. Long press to switch the keyboard language.
④	.	Short press once to enter a full stop . Long press to choose symbols and other characters. *

To enter the text:

1. Launch a text field, in this example, we will use the Messaging app to compose a message. This action will trigger the opening of the On-Screen Keyboard.
2. Tap on the delete key to remove characters located to the left of the cursor.
3. Tap **?123** to input numbers. Tap **ABC** again to switch back to letters.

SECTION 3 BASIC OPERATIONS

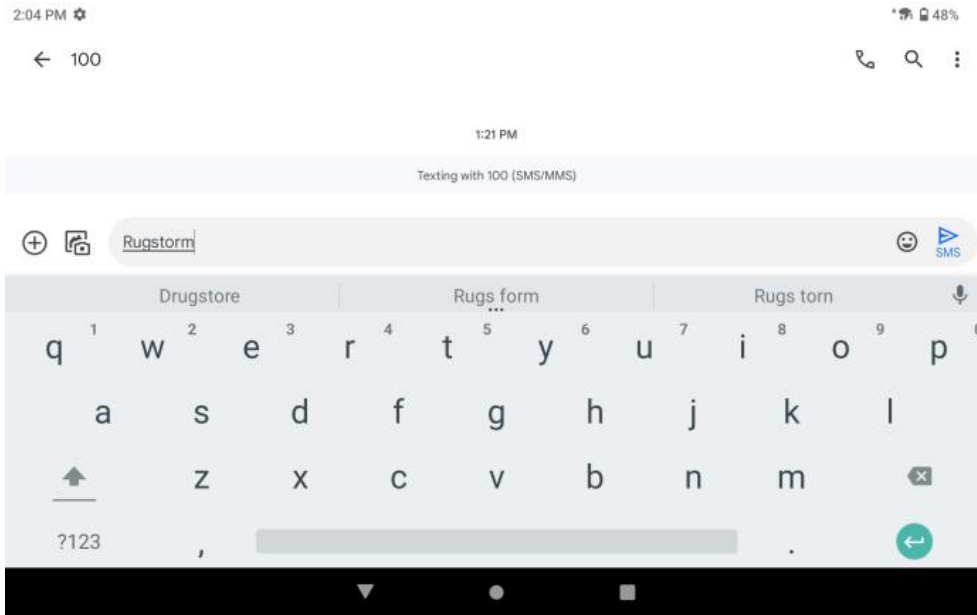

4. To view additional symbols, tap **= \ <** on the numeric keyboard.

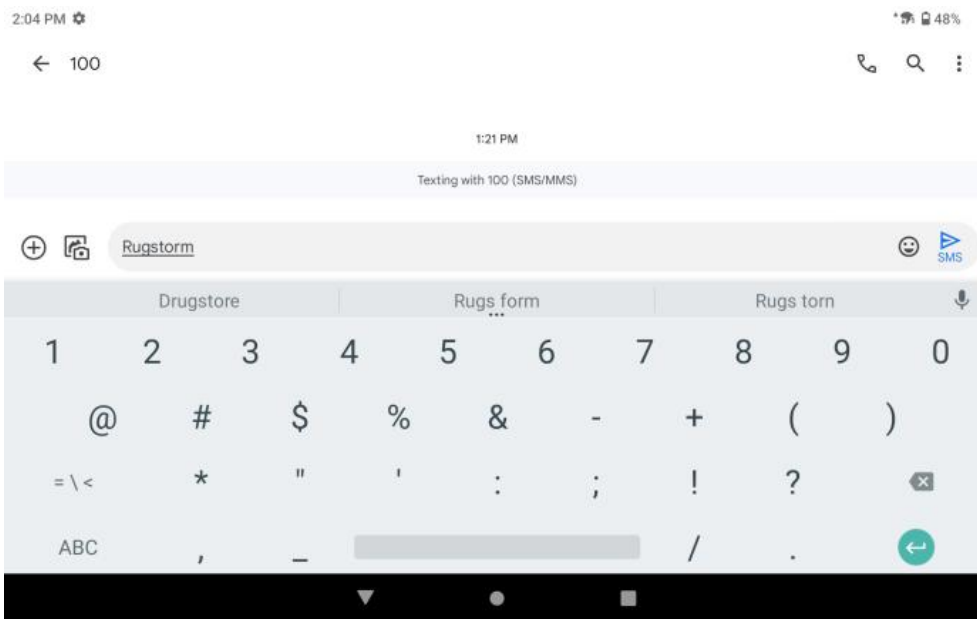

5. To enter symbols and other characters, press and hold one of the keys on the top row, then slide your finger upwards to access a list of available options. Release your finger when you have found your desired selection.

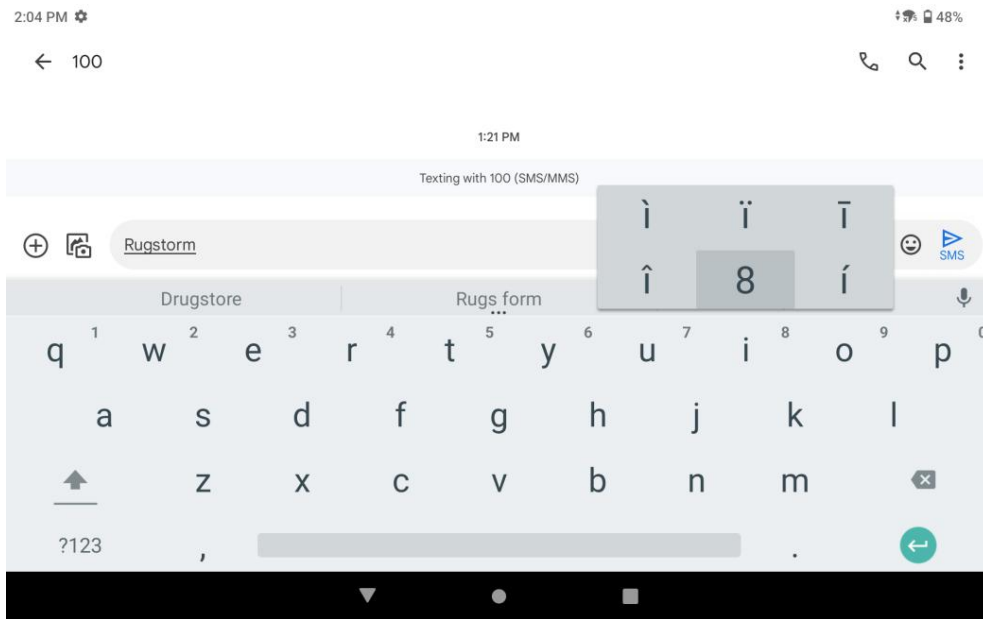

6. To close the On-Screen Keyboard, press either the back key on the screen or the back button on the top of the tablet.



3.4 Display Settings

Display setting provide the access to configure the brightness and other screen setting.

1. Swipe up from the bottom of the home screen, launch **Setting**, and then tap **Display**.

Content	Description
Brightness level	To adjust the brightness of the screen by tap and drag.
Adaptive brightness	To optimize brightness level for available light.
Lock screen	To configure all options about notification.
Screen timeout	To set up the period of the tablet is idle before entering sleep mode
Dark theme	To set up the tablet to black background to help keep battery alive longer on some screens.
Font size	To make the text on screens smaller or larger.
Display size	To make the items on your screen smaller or larger. Some apps on your screen may change position.
Auto-rotate screen	For switching the orientation of the screen when user turns the device sideways or upright.
Screen saver	To control what happens when the tablet is docked and/or sleeping, turn screen saver on.



3.5 Sound Settings

Sound setting provide the access to customize the tablet's rings, alarm and other notification settings. This enables you to specify how and at what volume the device will alert you when receiving calls, notifications, or alarm sounds.

3.5.1 Sound Setting

1. Swipe up from the bottom of the home screen, select **Settings**, and then tap **Sound**.

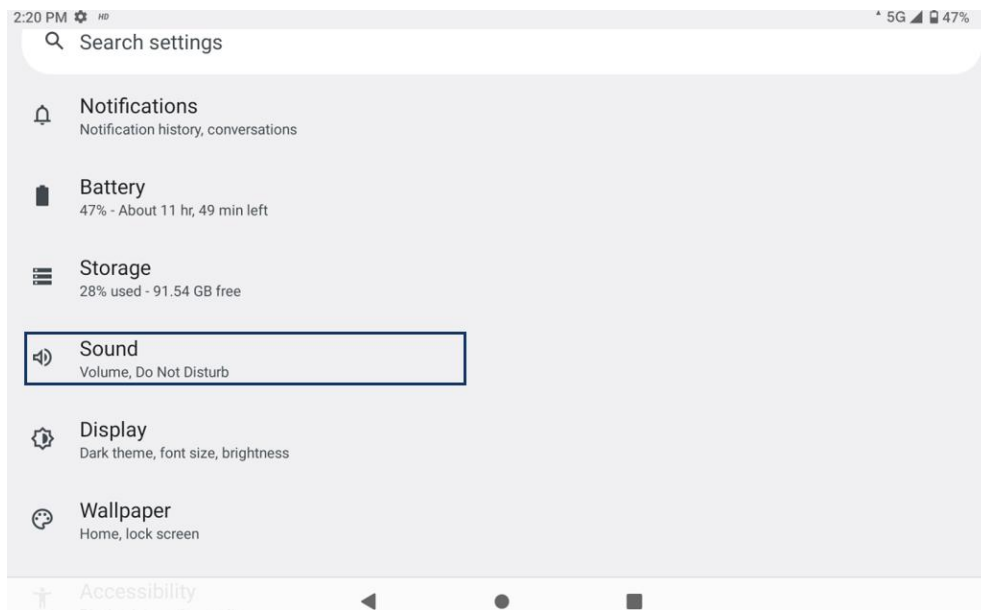

2. In the **Sound** user can select Media volume, Call volume, Ring volume, Alarm volume and other sound settings.

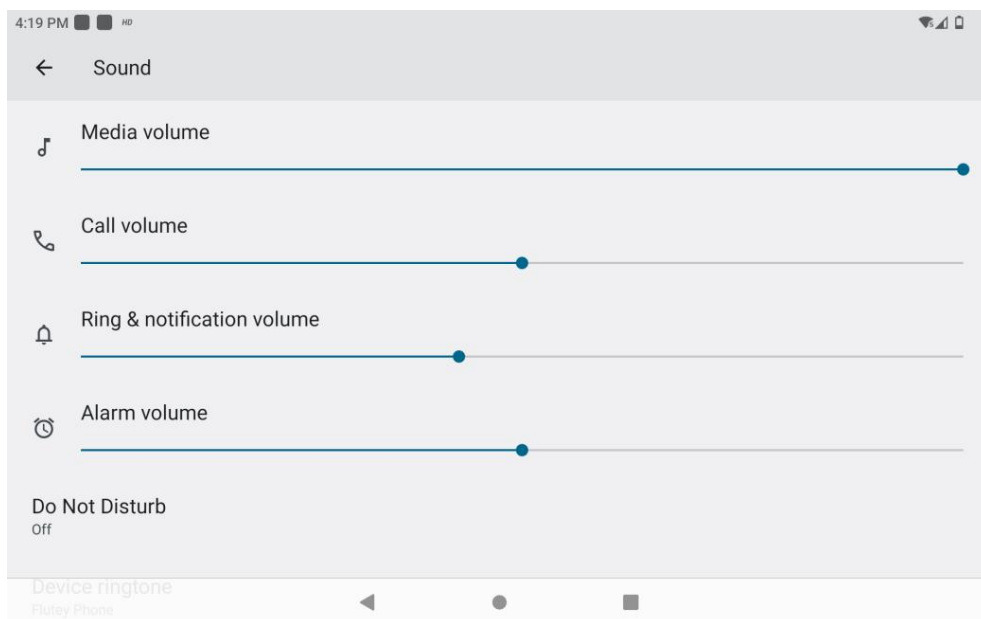



3.5.2 Adjusting Volume

To Adjusting Volume

Press the volume keys to change the media volume (On Home screen) or earpiece volume (during a call). Press the volume key again to set up Vibration mode.

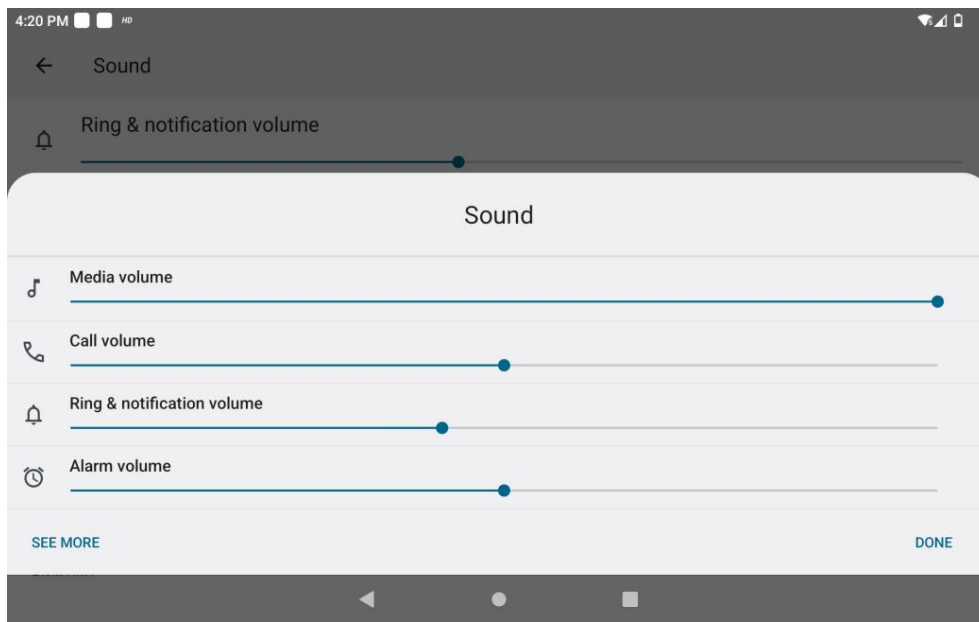



3.6 Language and Keyboard Setting

Language and keyboard setting provides the access to select the language for the text on your tablet and configure On-Screen Keyboard, including words that you have added to its dictionary.

1. Slide up from the bottom of home screen, select **Setting**, and then tap **System**.

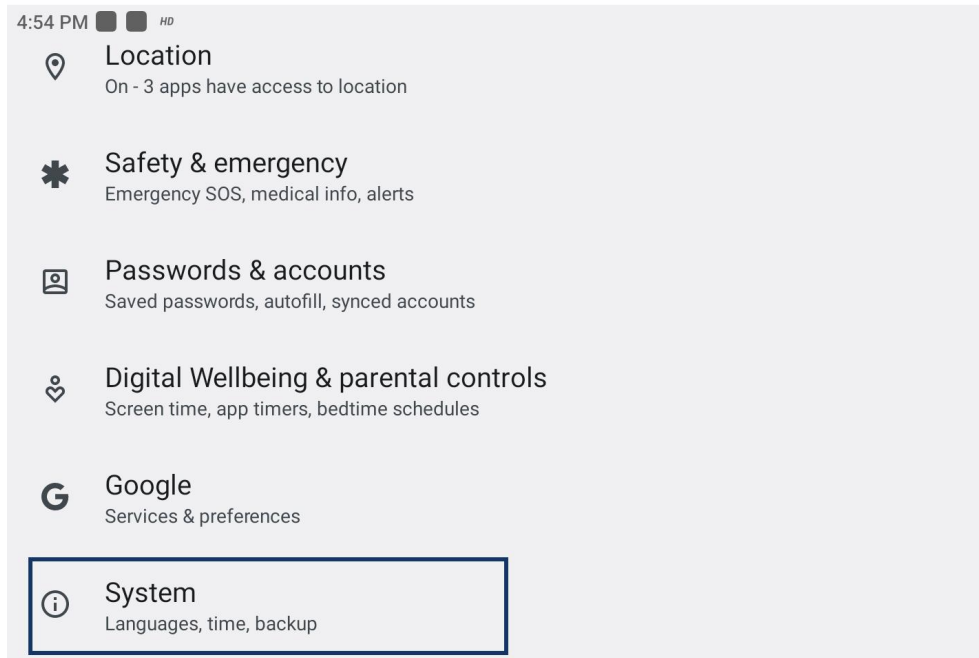

2. Select **Language & Input**.

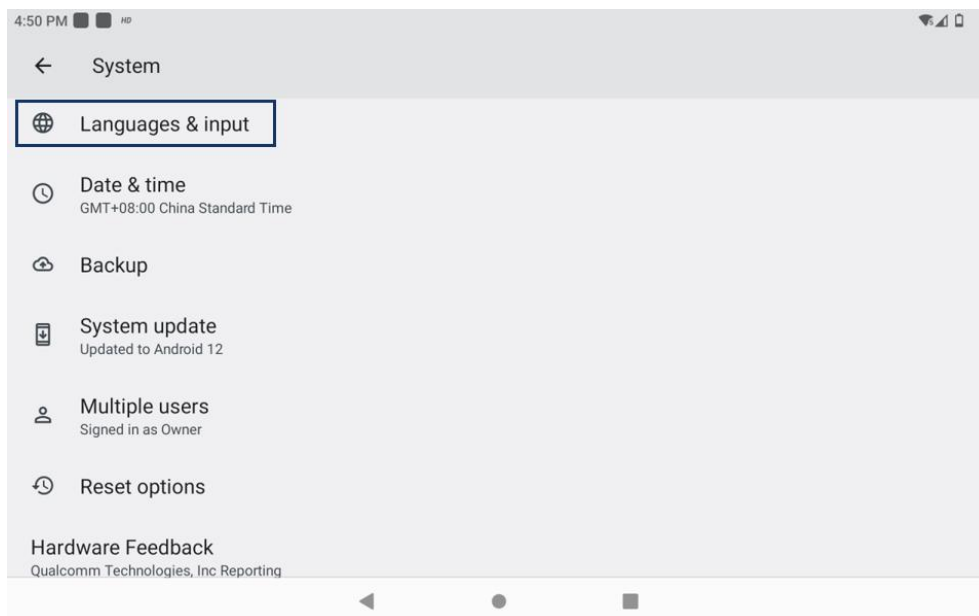

Keyboard & input methods

- On-screen Keyboard – shows default Android Keyboard (AOSP).
- Physical Keyboard – allows the user to apply physical keyboard settings if connected.

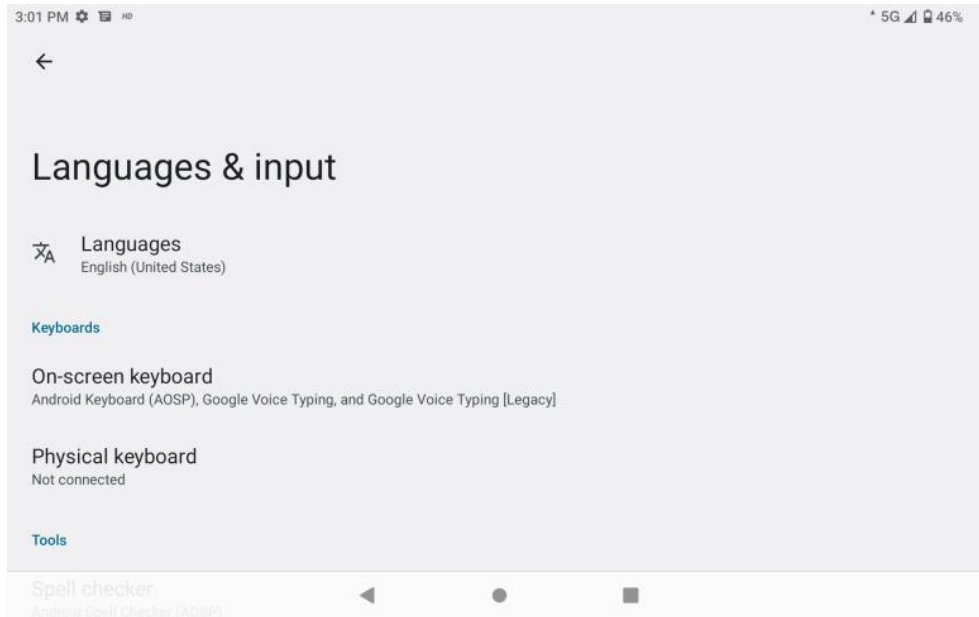

Change the system language

1. Tap **Setting** → **Language and input** → **Language**.
2. Tap **Add a language** to select the intended language, and drag it to the first location.

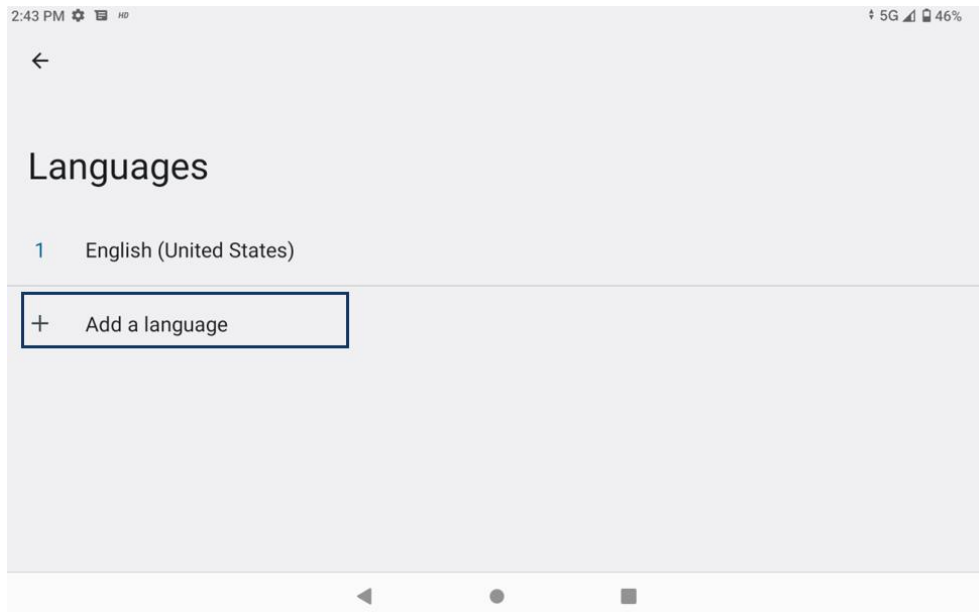



Change the keyboard language

1. Tap **Setting** → **Language and input** → **On-screen keyboard**, then tap **Android Keyboard (AOSP)**
2. Select **Language**, and then close “**Use system languages**”.
3. Select the intended language in **Active input language** list.





3.7 Managing the Power

Battery setting provides the access to manage the battery, including the battery usage display, battery saver and battery charging.

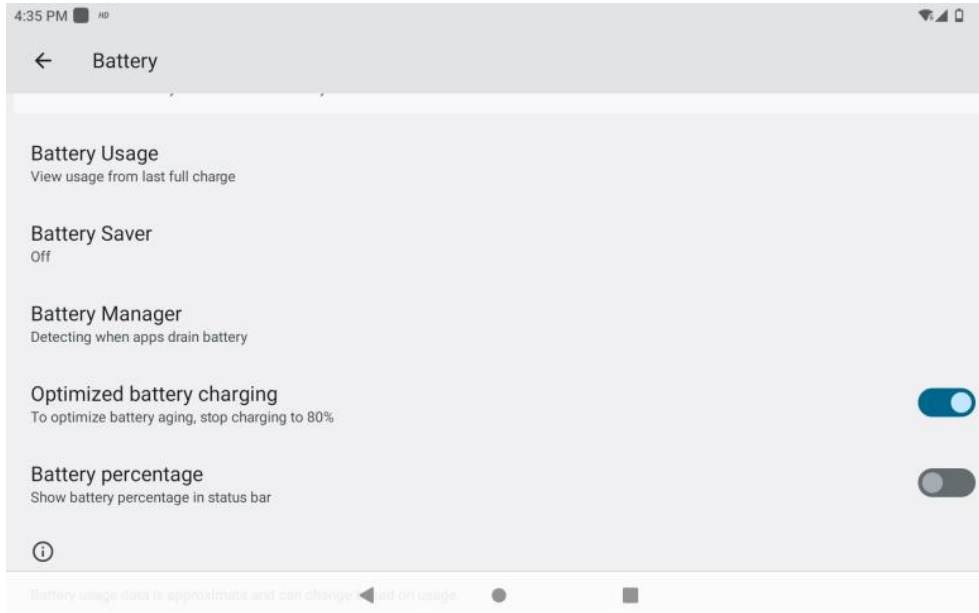

Set the Battery Saver

Tap **Setting** → **Battery** → **Battery Saver**.

- **Use Battery Saver** — Battery Saver is always open.
- **Set a schedule** — Battery Saver is open when battery percentage reaches the target.

Optimize battery charging

Tap **Setting** → **Battery** → **Optimized battery charging**.

Enable the function will restrict the maximum charge of the battery to 80% of its total capacity in particular situations. In such situations, the battery will be regarded as fully charged when it reaches 80% capacity.



3.8 About Tablet

About Tablet includes information about user's device.

Information	Description
System updates	To offers details concerning the local or online update options for your devices.
Legal information	To list details about the model number, Android Version, Baseband version etc. this information is useful if user need to work with support team.
SIM status	To display the available of the SIM card.
Model	To display the model name of the current device.
Android version	To display the current Android operating system version the device running.
Build number	To display the current operating system version based on Android version.



Section 4 Connecting Networks and Wireless Devices

This section provide the instruction to connect SA100 to network and peripheral devices.

4.1 Mobile Networks Connection

SA100 support SIM hots swapping. When users insert a SIM card from a service provider into SA100, the device will be set up to utilize the provider's networks for voice calls and data transmission. It is important to note that various locations may offer different mobile networks, requiring the user to manually configure SA100 to connect to specific networks.

4.1.1 Checking Mobile Network (4G/LTE) Connection

1. Swipe up from the bottom of the home screen, tap **Settings** .
2. Tap **Network & Internet**.

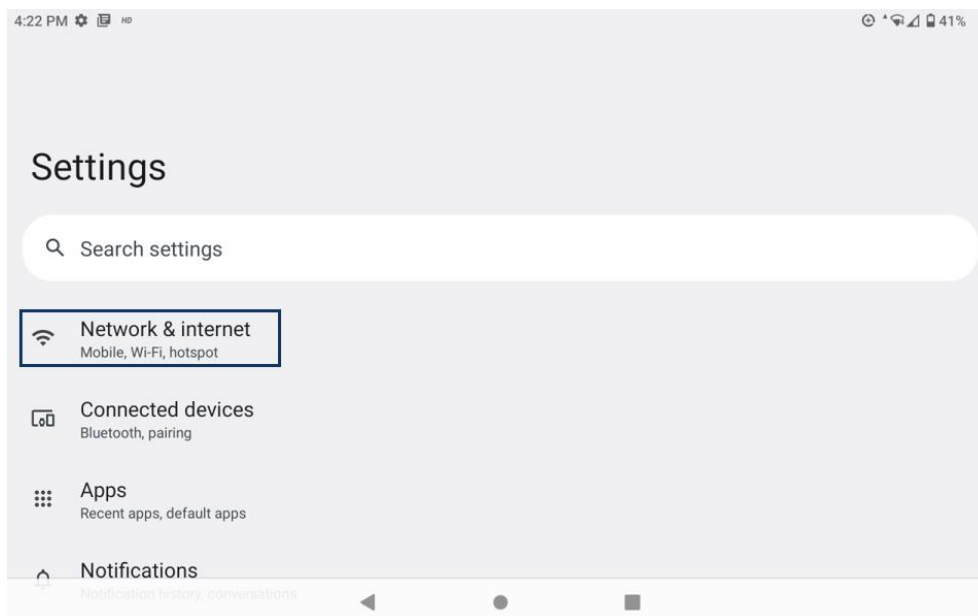

3. Tap **Mobile networks** to check the network connection.

4.1.2 Managing Data Service

To turn on Data Service

1. Swipe up from the bottom of the home screen, tap **Settings** .
2. Tap **Network & Internet** and tap **Mobile network**.
3. Tap the switch to turn on **Mobile data**.

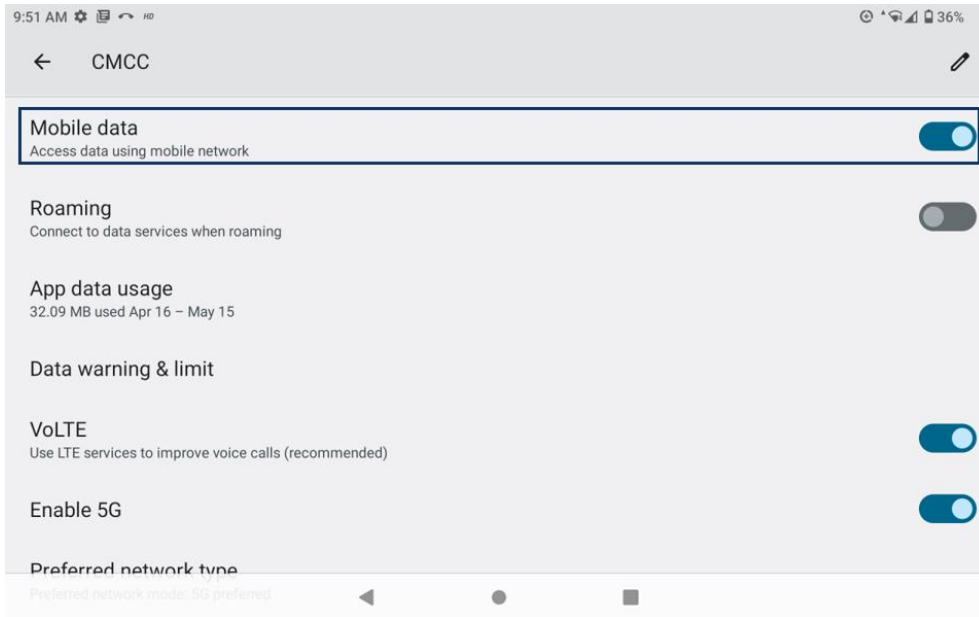

To Turn on Data saver

User can reduce data usage by using Data saver feature to prevent some apps from sending or receiving data in the background.

On the setting screen, tap **Network & Internet** → **Data Saver** .

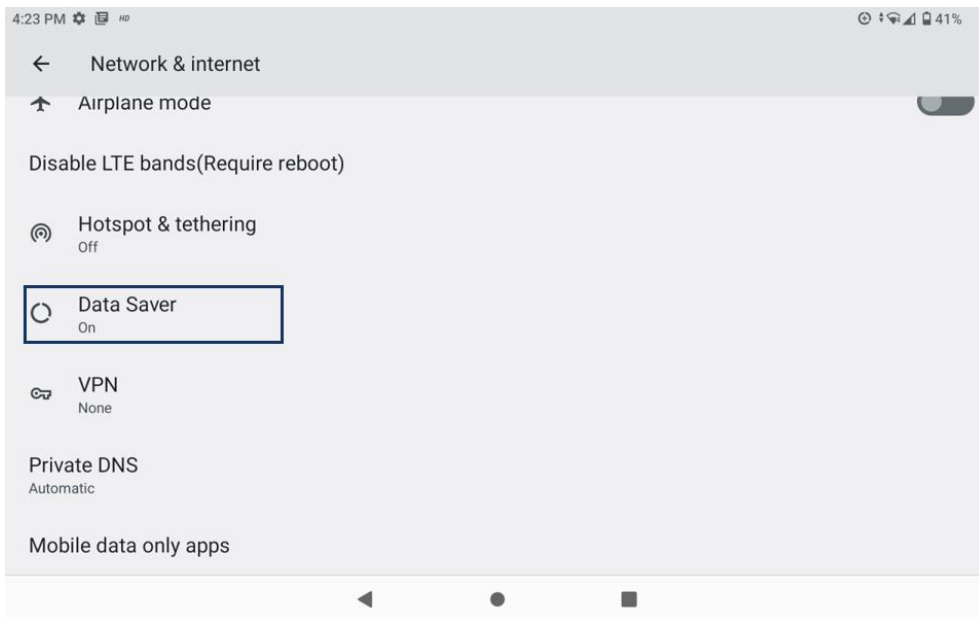

Note:

- To select apps to use data without restriction, tap **Unrestricted data** and select apps.
- When Data Saver is on, User can check and manage data saver status on the status bar.





To Turn on Mobile data only apps

Select apps to always use the mobile data even when your device is connected to a Wi-Fi network.

On the Setting screen, tap **Network & Internet** → **Mobile data only apps**.

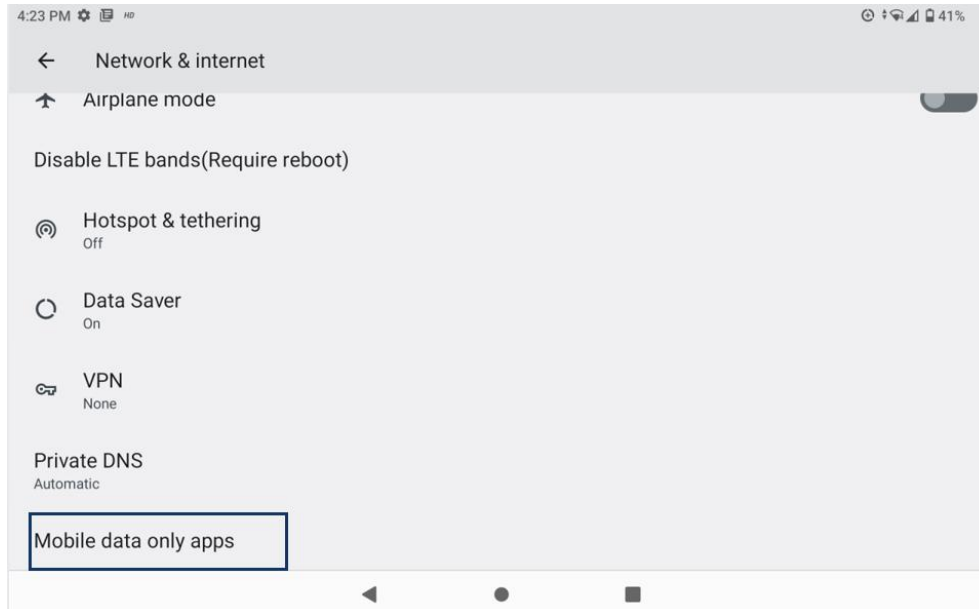



4.2 WLAN Networks Connection

User can use Wi-Fi feature to connect to a Wi-Fi network and access the Internet or other network devices.

To Turn on WLAN Network Connection

1. Swipe up from the bottom of the home screen, tap **Settings**.
2. Tap Network & Internet and tap the switch to enable the WLAN.

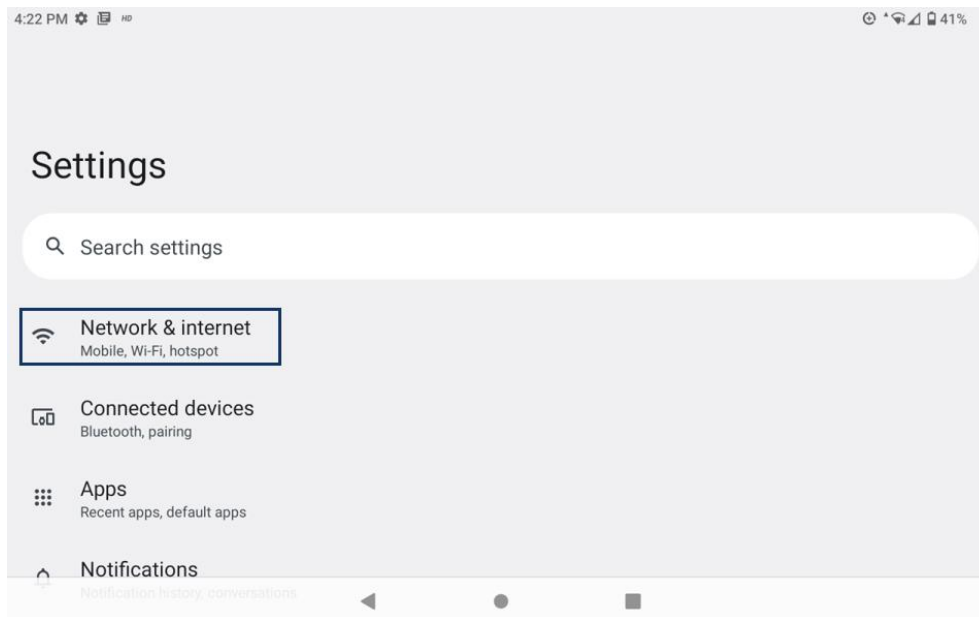

3. The device scans for available Wi-Fi and displays the list of it. Secured networks are denoted by a lock icon. If the tablet detects a network that you have previously connected to, it will automatically establish a connection to it.

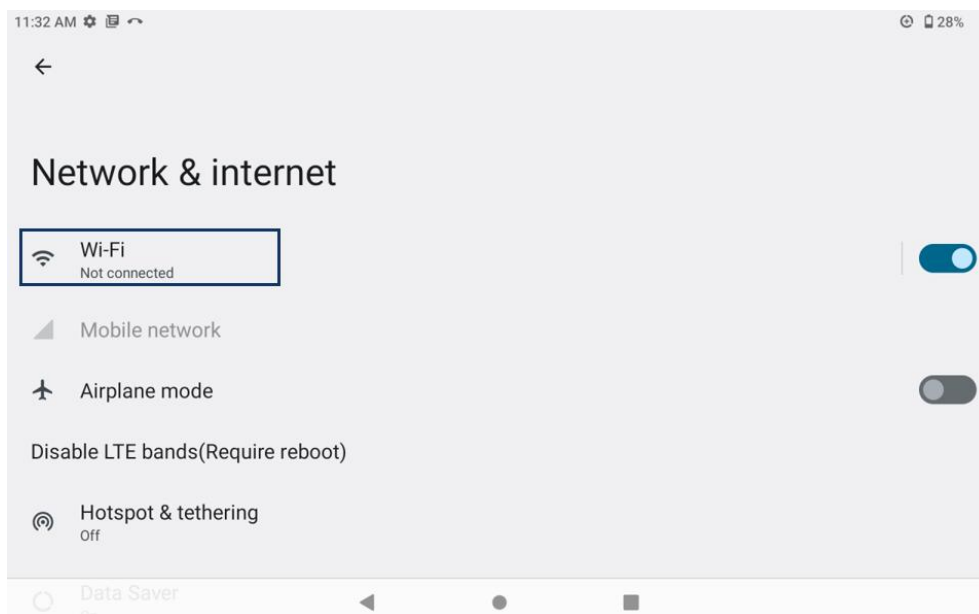



4. Tap a network to connect it.
 - If the network is open, you are prompted to confirm that you want to connect it by tapping Connect.
 - If the network is secured, users are prompted to enter a password or other credentials.



5. To check the details about the speed, security, IP address and related settings, tap its name in the WLAN settings screen.

To add a Wi-Fi Network

1. Turn on WLAN, in the WLAN settings screen, tap **+ Add network** (at the bottom of the list of discovered networks).

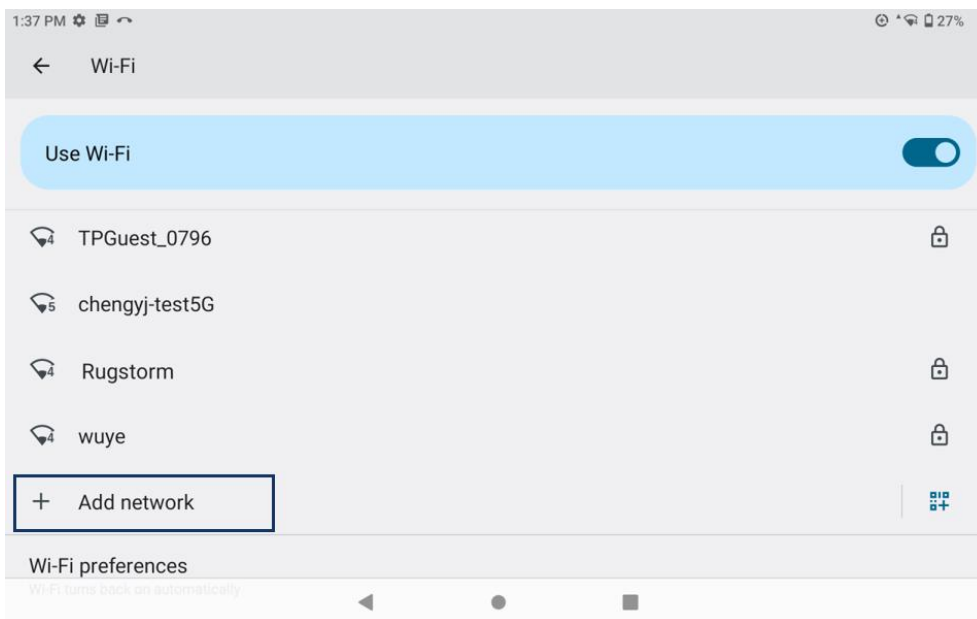



2. Input the SSID (name) of the network, if the network is secured, tap the security menu and then tap the type of security deployed on the network.

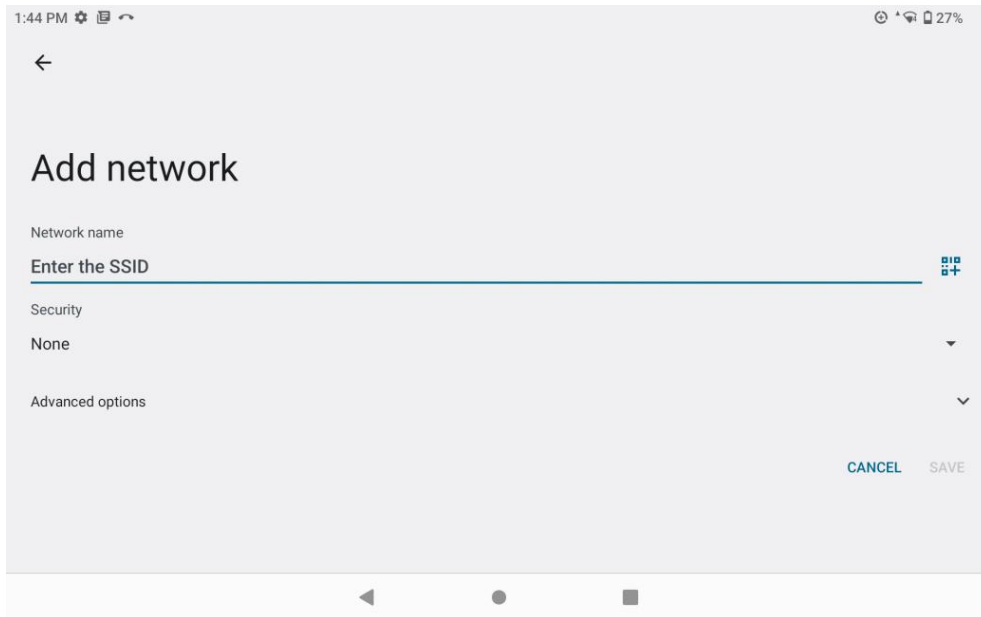

3. Enter any required security credentials.
4. Tap **Save**.



4.3 BT Devices Connection

When BT feature is turned on, the tablet can communicate with other nearby Bluetooth devices.

4.3.1 Turn on BT Connection

1. Swipe up from the bottom of the main screen, tap **Settings** .
2. Tap **Connected devices**, and tap **Connection preferences** .

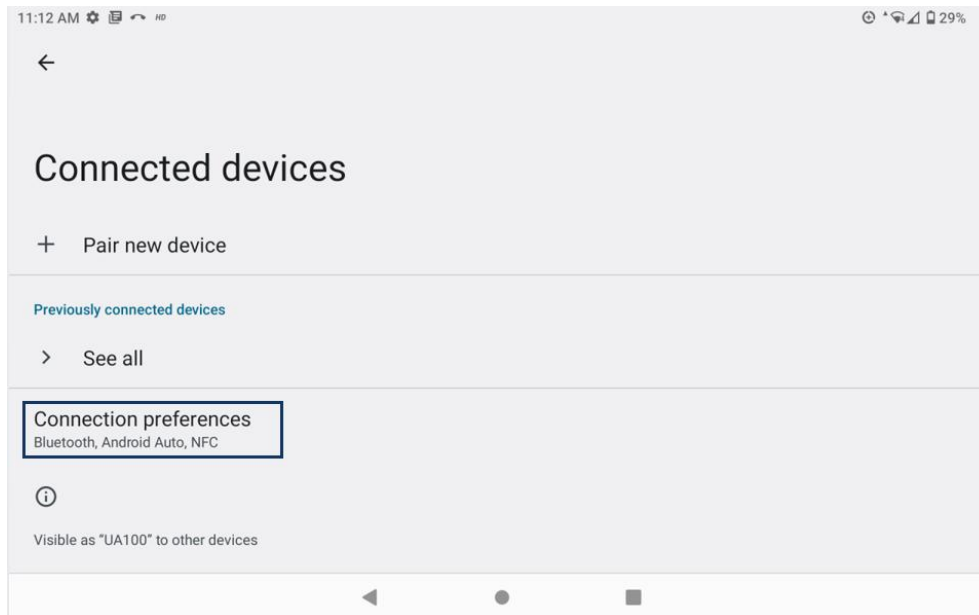

3. Tap **Bluetooth** and toggle the on/off switch to turn on the BT.

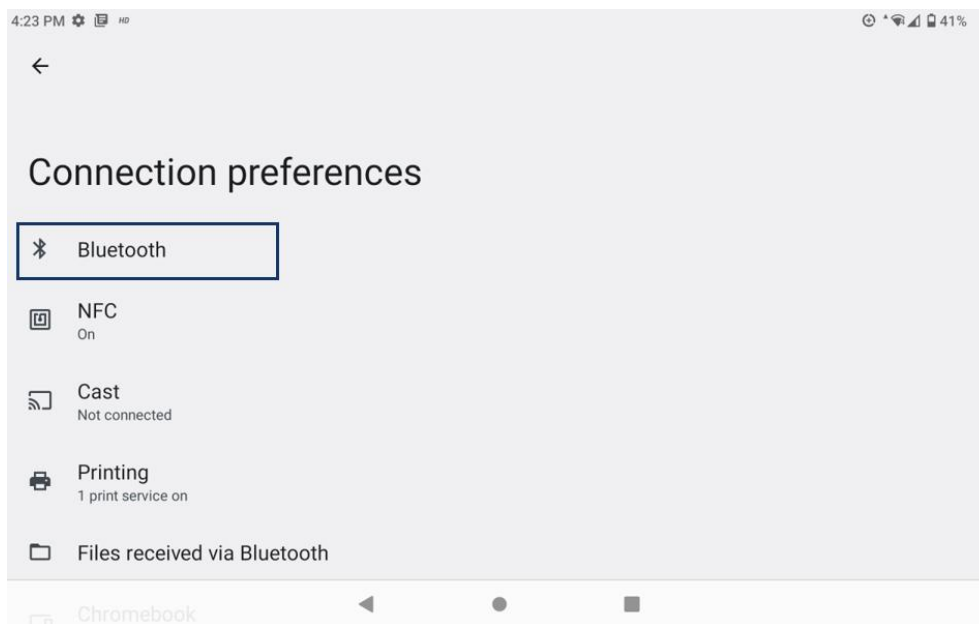

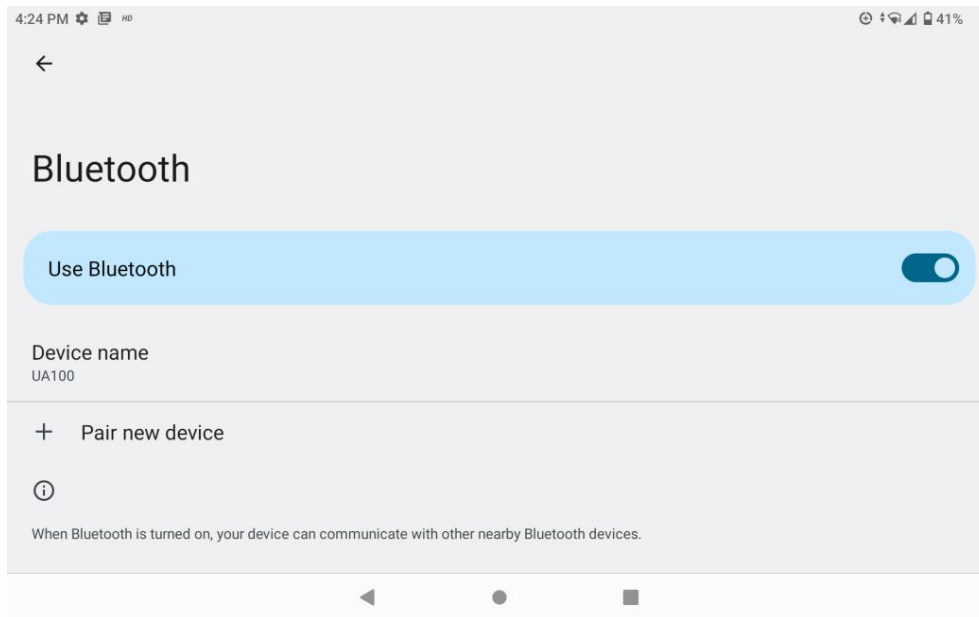

4.3.2 Connecting/Disconnect the BT Device

To Connect the BT Device

1. Swipe from the bottom of the main desktop, tap **Settings** .
2. Tap **Connected devices** .
3. Tap **Pair new device**. The system will automatically scan and display the IDs of all available BT device in range.

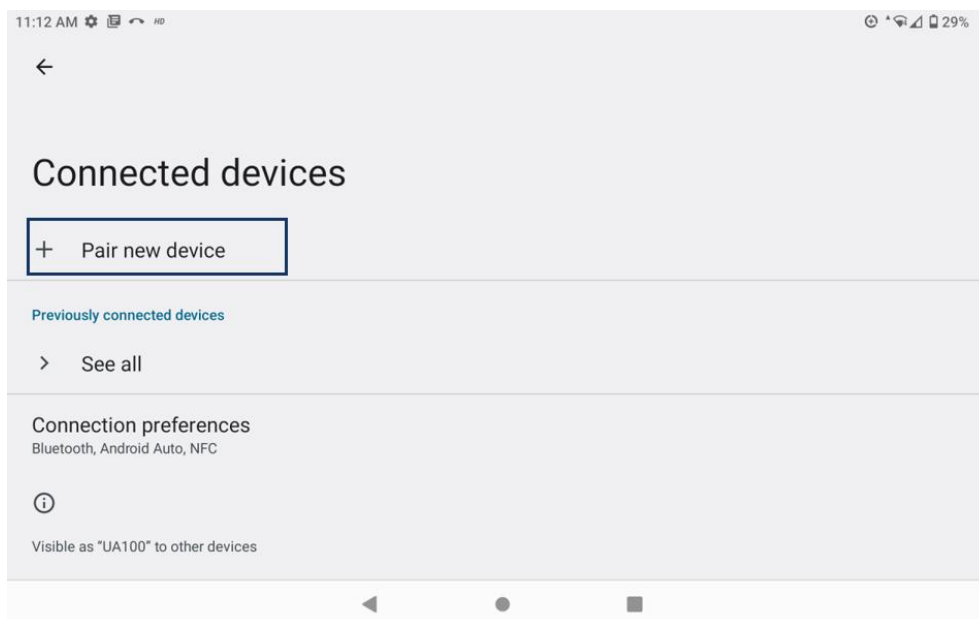

4. Select the device to be paired.

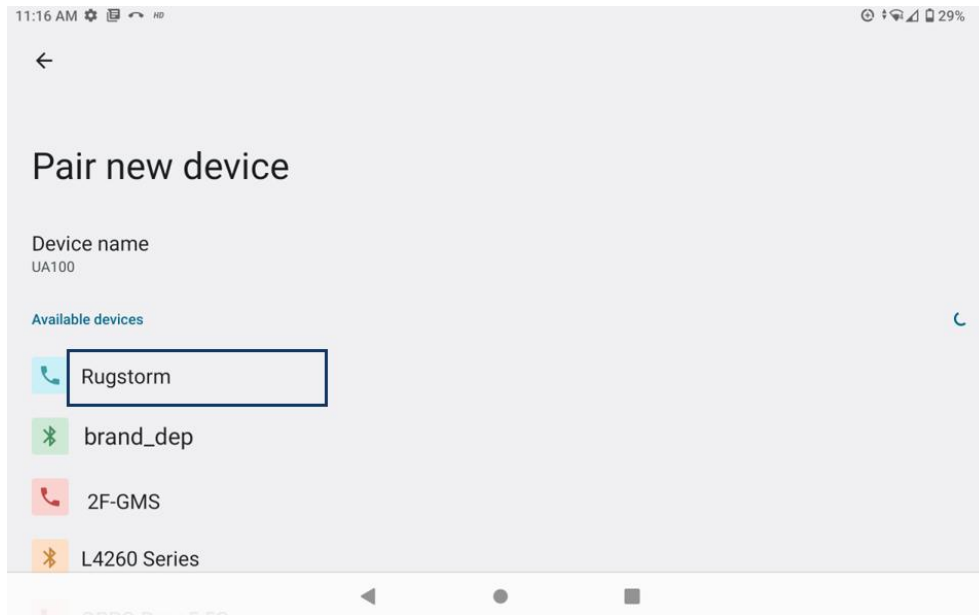

To Disconnect the BT Device

1. Tap the device in the BT settings screen.

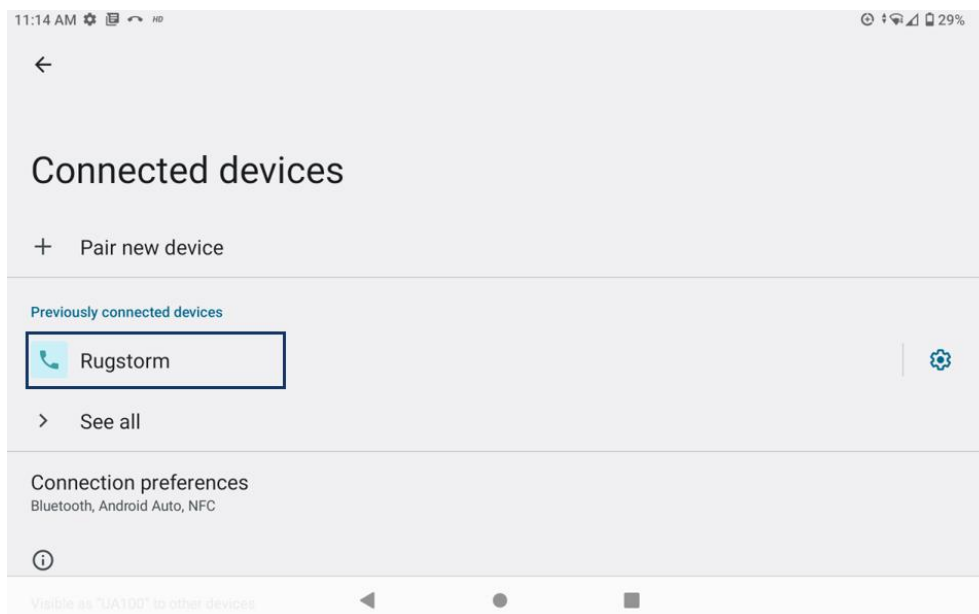

2. Tap **FORGET** to disconnect.

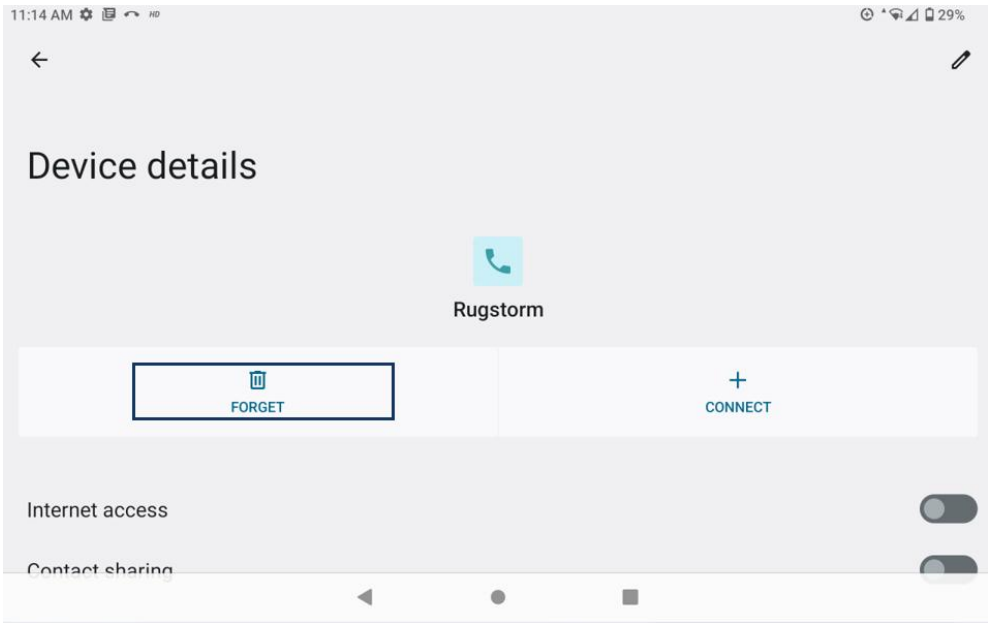



4.4 Using Barcode Reader (Optional)

The barcode scanner is an optional feature and powered by Honeywell® modules. Refer to your order specifications for additional information. For additional details, please contact our sales window for more details.



4.5 Using NFC Tags

The tablet can read NFC data and also transmit data to other NFC-enabled devices. When using NFC, make sure to unlock the screen. If the device encounters difficulty reading, try to reposition the card.

Note:

NFC Reader support protocol: Type A, Type B, ISO/IEC 15693.

NFC mode is enable default. To deactivate or re-activate NFC, follow these instructions:

1. Swipe up from the bottom of the home screen and tap **Setting**.
2. Tap → **Connected devices** → **Connection preferences** → **NFC**.

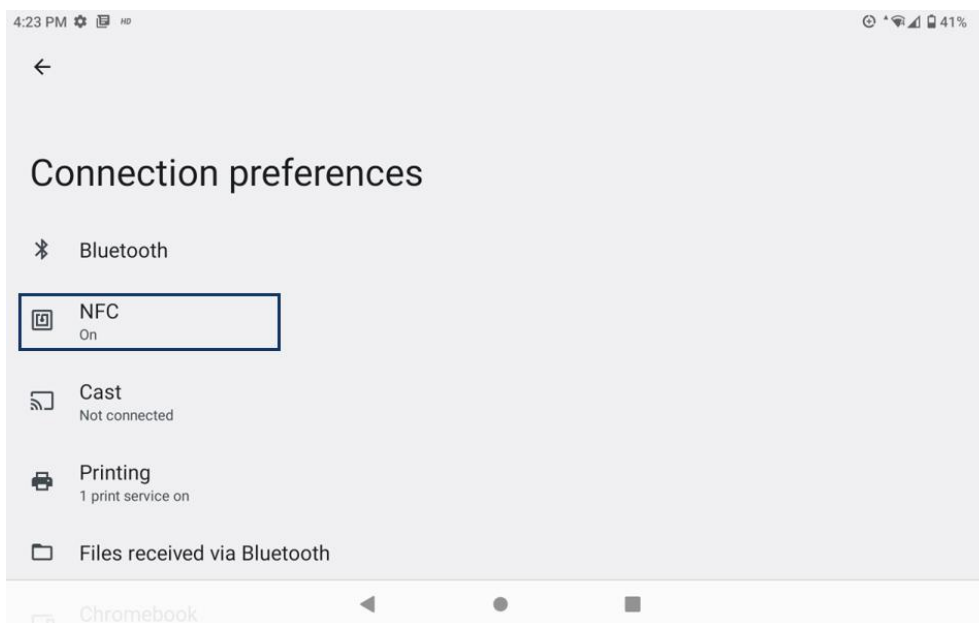

3. Toggle the switch to turn on the NFC.

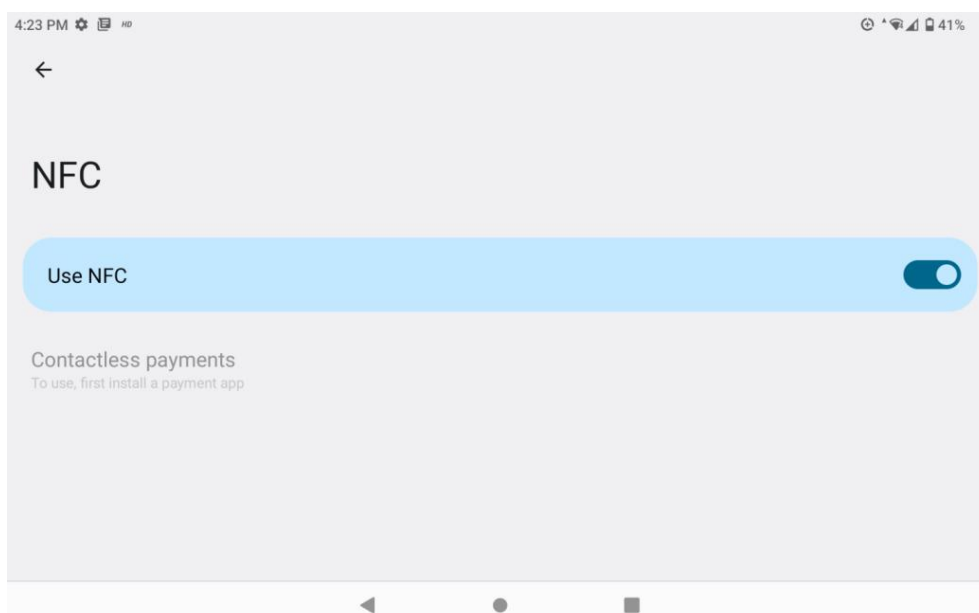



Section 5 Troubleshoot

Computer issues can stem from hardware, software, or a combination of both. Whenever you encounter a problem, it is likely a common issue that can be easily resolved. In this section, we will guide you on the necessary steps to take when troubleshooting typical computer problems.

To assist you further, here are some helpful tips to follow when faced with any problem:

- Firstly, attempt to identify the specific component of the Tablet PC that may be causing the problem.
- Prior to turning on the Tablet PC, ensure that all peripheral devices are properly powered on.
- If there is an issue with an external device, verify that the cable connections are secure and correctly aligned.
- Confirm that all device drivers are accurately installed.
- Take note of any observations you make. Are there any error messages displayed on the screen? Do any indicators light up? Are there any audible beeps? Providing detailed descriptions will be beneficial when seeking assistance from service personnel.

If any problem persists after you follow the instructions in this section, contact an authorized dealer for help.

Nothing appears on the screen.

- The tablet may be in sleep mode. Press the power button to wake up the display.
- The brightness level may be too low. Increase the brightness.

The screen suddenly turns blank and the power indicator goes off.

- Make sure the AC adapter is properly plugged in.
- If running on battery power, the battery may be drained, charge the battery.

Wireless LAN signal quality is poor.

- The tablet may be out of range. Move the tablet closer to the access point or another wireless LAN device associated with it.
- Verify if there are any interferences in your immediate vicinity, like microwave ovens or cordless phones. Relocate the tablet computer away from objects that may cause interference.

I cannot connect to another wireless LAN device.

- Make sure that wireless LAN feature is powered on.
- Make sure that the SSID setting is the same for every wireless LAN device in the network.



- Your Tablet PC is not recognizing changes. Restart the tablet computer.
- Make sure the IP address or subnet mask setting is correct.

I cannot connect to another device with Bluetooth.

- Make sure that both devices have Bluetooth powered on (For the Tablet , check windows setting to see if Bluetooth is powered on).
- Make sure that the distance between the two devices is within 10 meters and there are no walls or large obstructions between the devices.
- Make sure the both devices are powered on and configured to be discoverable.
- Make sure that both devices are compatible.

The GPS application cannot find my location.

- Make sure that GPS is turned on.
- Make sure that GPS receiver and the location sensor are enabled in Setting.
- The tablet computer may be out of coverage area. Move your tablet computer outdoors or closer to a window.
- Check if your surroundings have interferences, such as microwave ovens, cordless phones. Move the tablet computer away from objects causing interference.

No sound is produced.

- Adjust volume of the tablet computer by pressing on the volume rocker.
- If using an external audio device, make sure that the cable is properly connected.

I cannot project the tablet computer display to another monitor.

- Make sure the VGA driver is installed.
- Make sure the output setting selected is correct.

Battery leaking or swollen.

- The lithium battery used in this tablet may swell after being charged/ discharged many times, but there is no problem regarding safety.
- Continued use in such a state may result in the battery getting jammed, so please stop using the battery, and purchase a new one.

Copyright Notice

This document may not be reproduced, duplicated, translated, or transmitted in any form or by any electronic or mechanical means without the prior written consent of the original manufacturer.

Trademark Notice

Brand and product names are protected by trademarks or registered trademarks owned by their respective owners.